









TELAI e CONTROTELAI PORTE BLINDATE DI.BIG

DISEGNI TECNICI
rev. 2021.09.23.

| | | |
|--------------|---|---|
| 25.1 | SCHEMA APERTURA PORTA A BILICO DI.BIG | |
| 25.2 - 25.3 | SCHEMA RIVESTIMENTI PORTA E SCHEMA ANTA FINESTRATA PORTA A BILICO DI.BIG | |
| 26.1 - 26.2 | CONTROTELAIO E TELAIO PORTA BLINDATA A BILICO DI.BIG - Sol. 20 |  |
| 26.3 - 26.4 | CONTROTELAIO E TELAIO PORTA A BILICO DI.BIG per rivestimento muro interno - Sol. 21 |  |
| 26.5 - 26.6 | CONTROTELAIO E TELAIO PORTA A BILICO DI.BIG per rivestimento muro esterno - Sol. 22 |  |
| 26.7 - 26.8 | CONTROTELAIO E TELAIO PORTA A BILICO DI.BIG per rivestimento muro interno e esterno - Sol. 23 |  |
| 26.9 - 26.10 | CONTROTELAIO E TELAIO PORTA A BILICO DI.BIG TUNNEL - Sol. 24 |  |
| 27.1 - 27.4 | CONTROTELAIO E TELAIO PORTA A BILICO DI.BIG CON FIANCOLUCE E SOPRALUCE | |
| 28.1 - 28.6 | CONTROTELAIO E TELAIO PORTA A BILICO DI.BIG CON PARETI LATERALI E SUPERIORI | |
| 29.1 - 29.2 | CONTROTEL. E TELAIO PORTA BLINDATA RASO MURO per rivestimento muro interno - Sol. 25 |  |

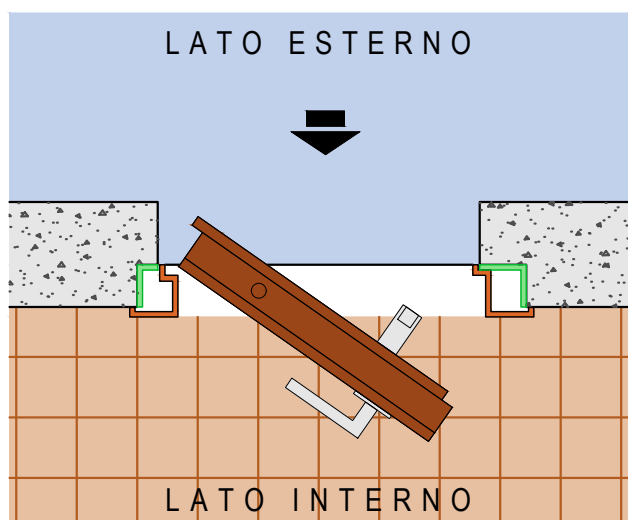

Porta a spingere DX

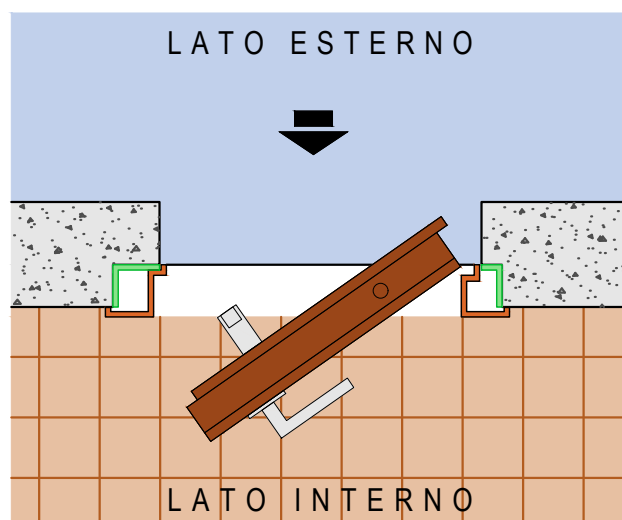

Porta a spingere SX

SCHEMA APERTURA PORTA

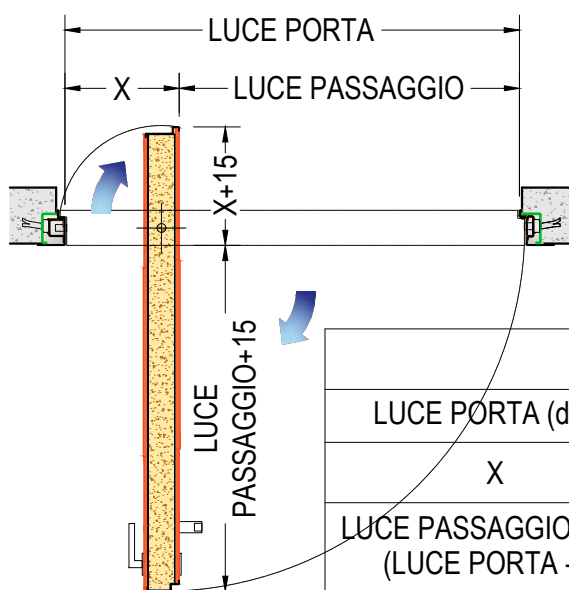

| CALCOLO LUCE PASSAGGIO | | | | | |
|---|-----------|-----------|-----------|-----------|-----------|
| LUCE PORTA (da-a) | 1100-1300 | 1301-1400 | 1401-1550 | 1551-1700 | 1701-1800 |
| X | 300 | 350 | 400 | 450 | 500 |
| LUCE PASSAGGIO (da-a) (LUCE PORTA - X) | 800-1000 | 951-1050 | 1001-1150 | 1001-1250 | 1201-1300 |

SCHEMA LUCE PASSAGGIO - LUCE X

LATO ESTERNO

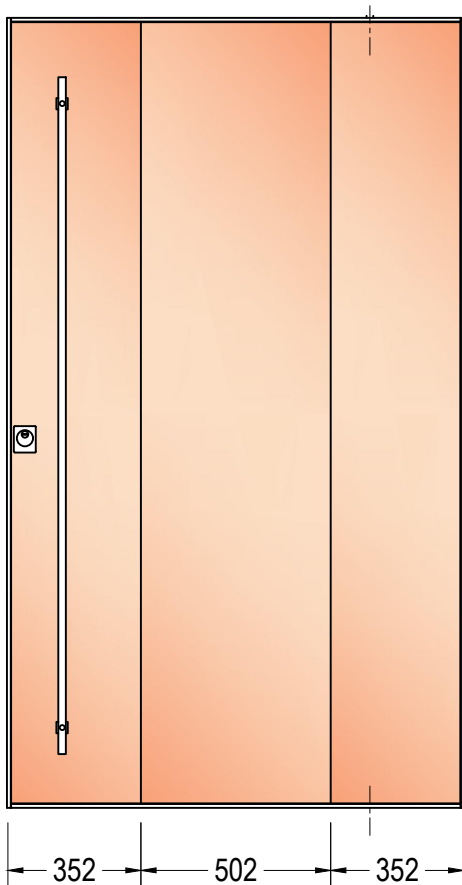
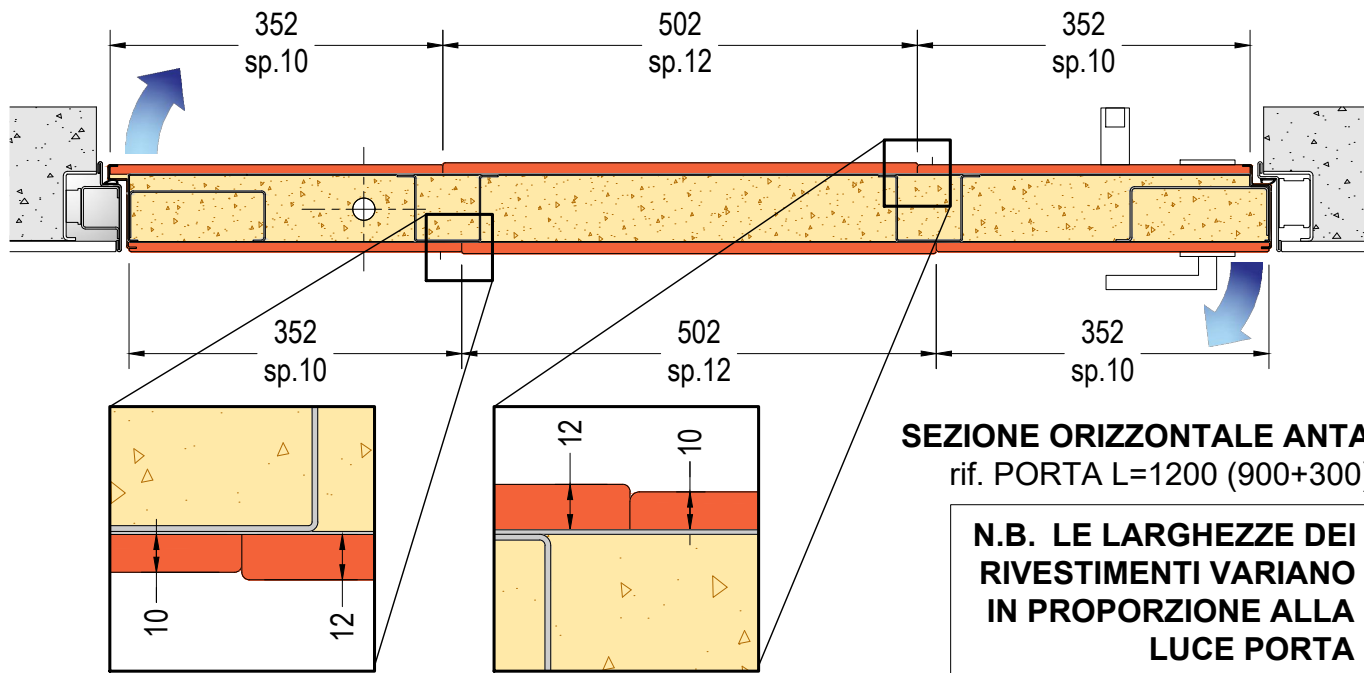

PROSPETTO ESTERNO ANTA
rif. PORTA L=1200

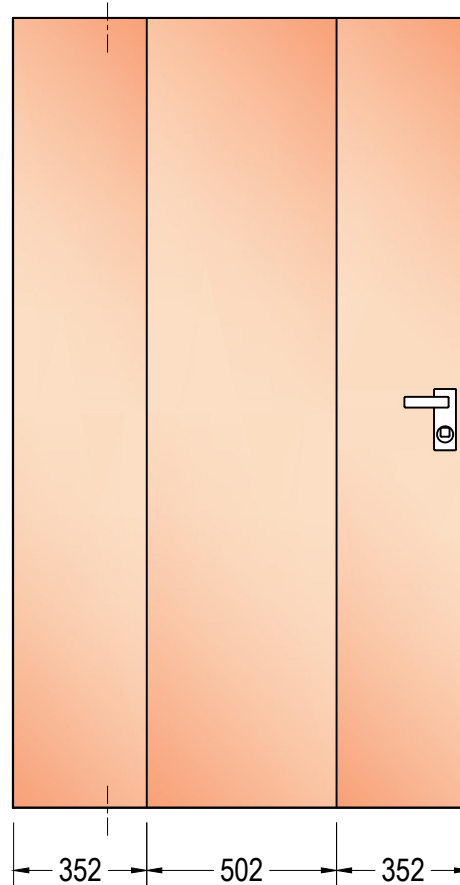

PROSPETTO INTERNO ANTA
rif. PORTA L=1200



SCHEMA RIVESTIMENTI STANDARD PORTA A BILICO DI.BIG

25.2

SEZI. ORIZZONTALE - scala 1:8 - PROSPETTI scala 1:20 v 1.0

DI.BI. PORTE BLINDATE Srl - Fano (PU) ITALY - www.dibigroup.com

LATO ESTERNO

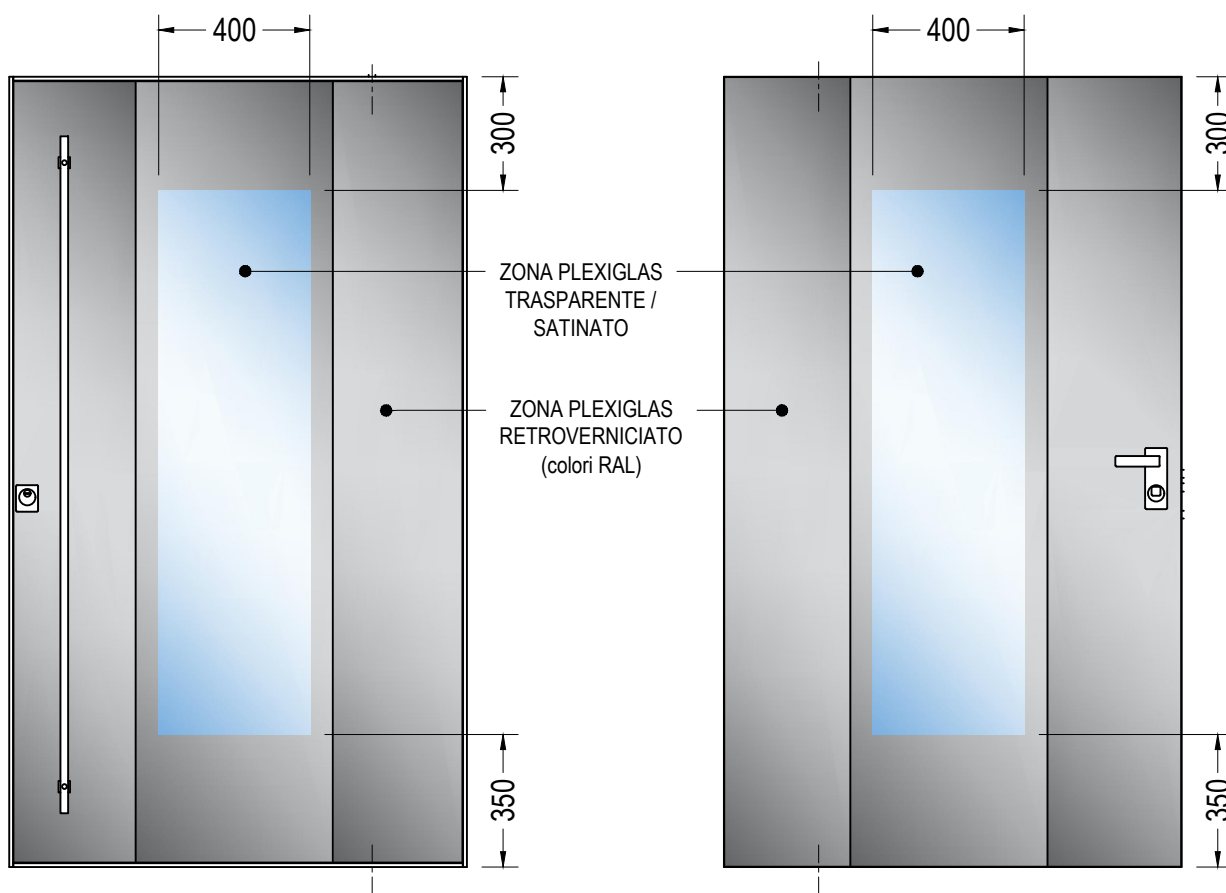
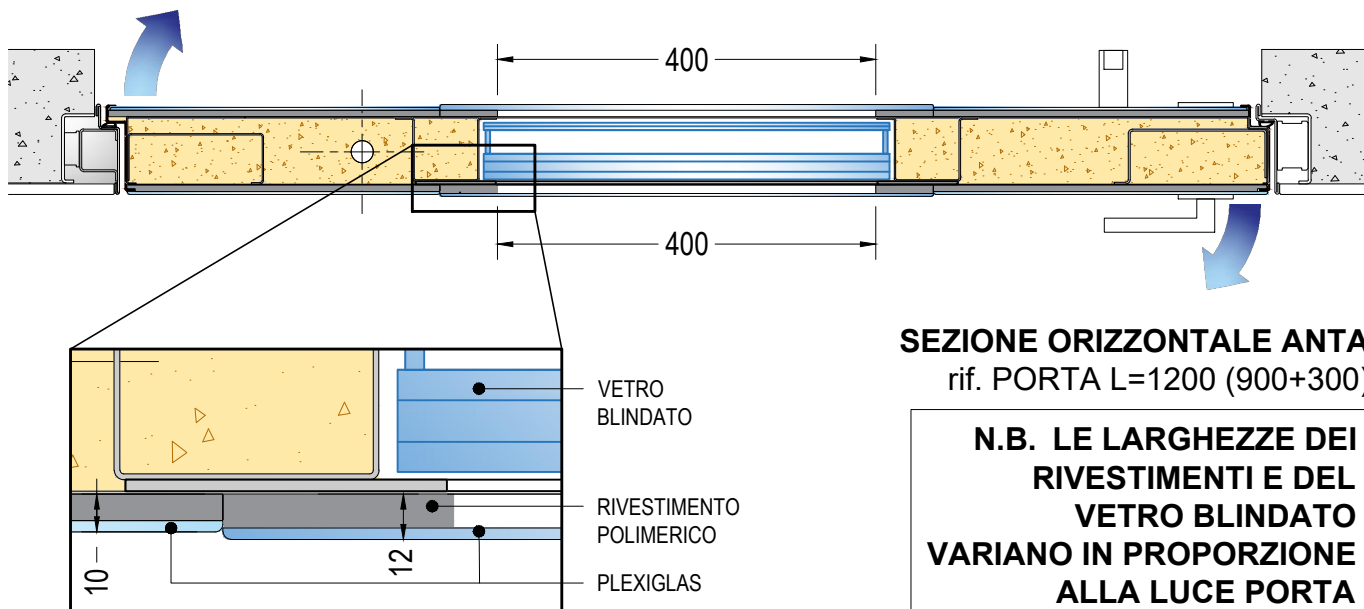

SCHEMA ANTA FINESTRATA PORTA A BILICO DI.BIG

25.3

SEZI. ORIZZONTALE - scala 1:8 - PROSPETTI scala 1:20 v 2.0

DI.BI. PORTE BLINDATE Srl - Fano (PU) ITALY - www.dibigroup.com

LATO ESTERNO

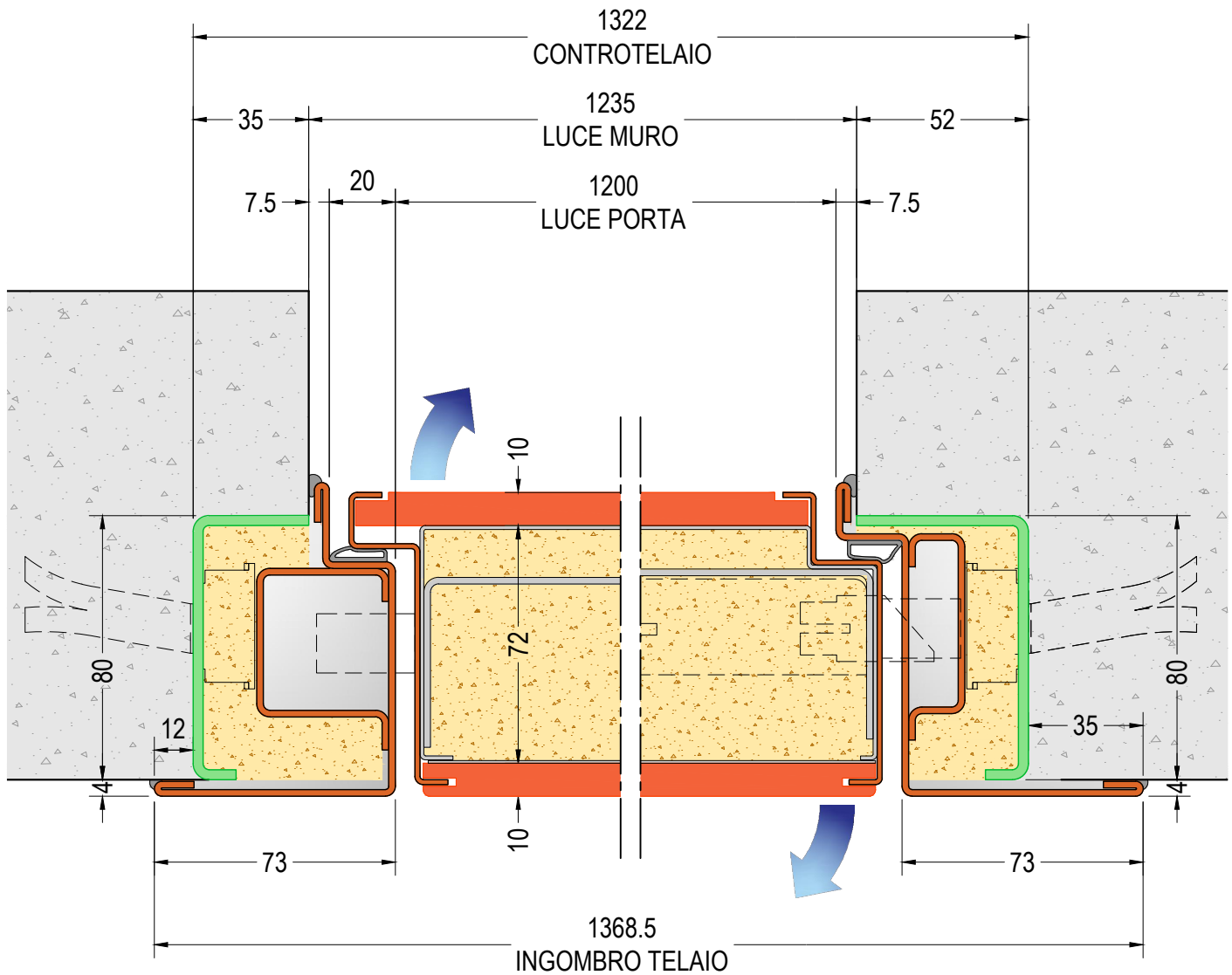

**SEZIONE ORIZZONTALE PORTA
MODELLO "A"**
rif. PORTA L=1200 (900+300)

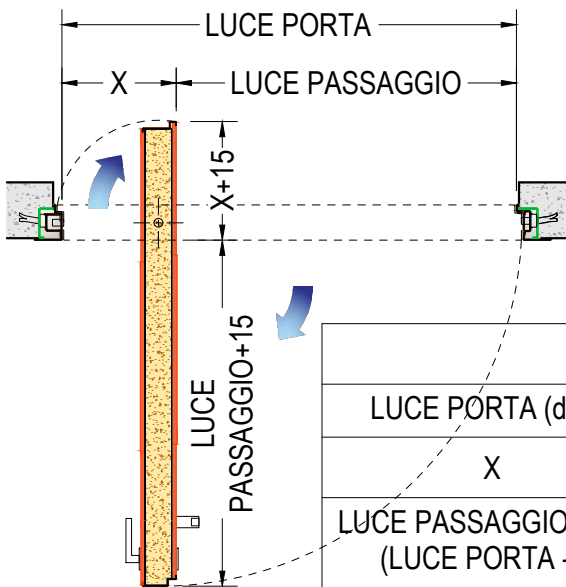

CALCOLO LUCE PASSAGGIO

| LUCE PORTA (da-a) | 1100-1300 | 1301-1400 | 1401-1550 | 1551-1700 | 1701-1800 |
|---|-----------|-----------|-----------|-----------|-----------|
| X | 300 | 350 | 400 | 450 | 500 |
| LUCE PASSAGGIO (da-a) (LUCE PORTA - X) | 800-1000 | 951-1050 | 1001-1150 | 1001-1250 | 1201-1300 |



**CONTROTELAIO E TELAIO
PORTA BLINDATA A BILICO
DI.BIG - Soluzione 20**

26.1

SEZIONE ORIZZONTALE - scala 1:2

v 1.6

DI.BI. PORTE BLINDATE Srl - Fano (PU) ITALY - www.dibigroup.com

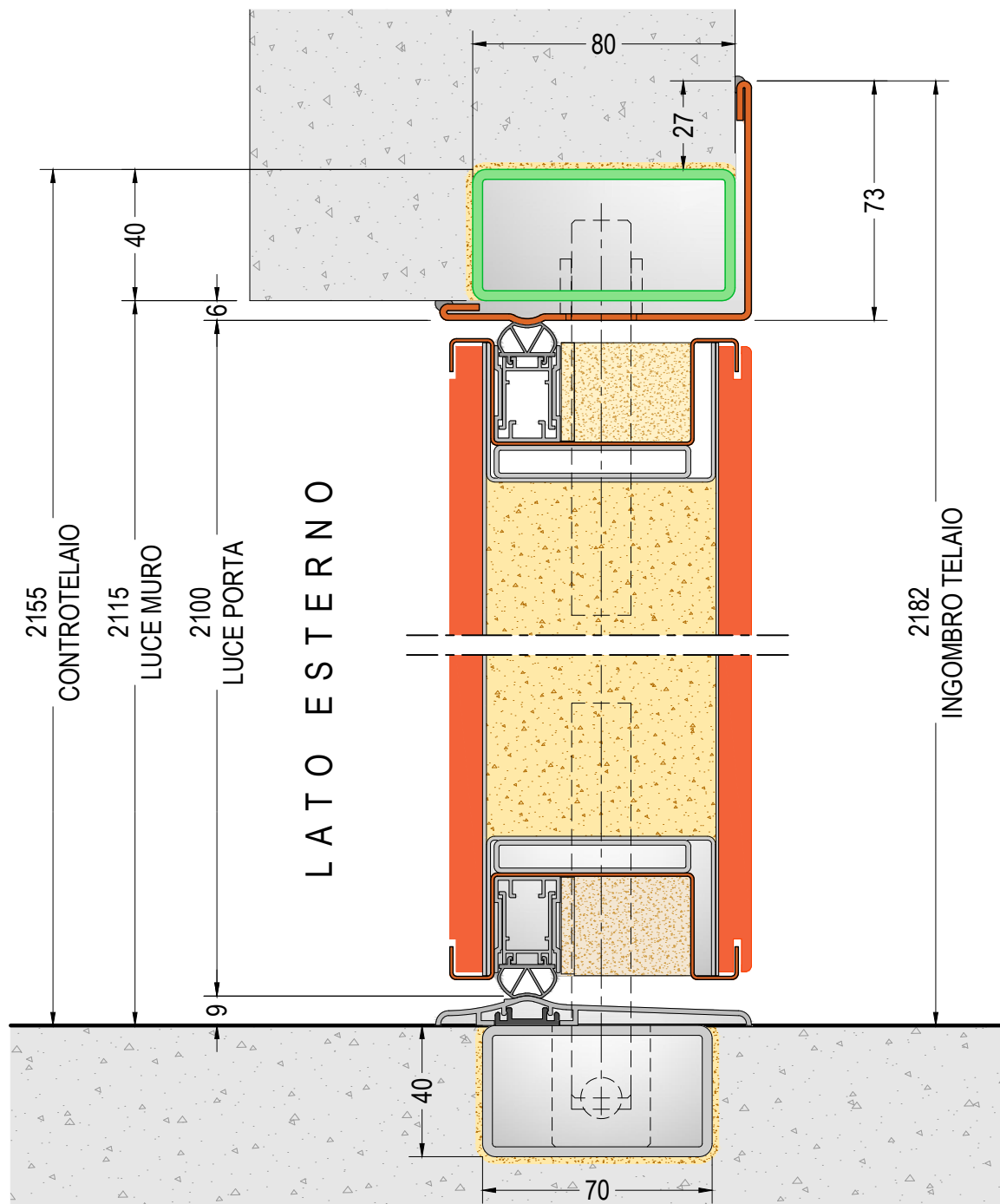

**SEZIONE VERTICALE PORTA
MODELLO "A"**

ref. PORTA H=2100

DIMENSIONI PORTA:

L=min. 1100 - max. 1800

H=min. 2100 - max. 2800



vista lato esterno



**CONTROTELAIO E TELAIO
PORTA BLINDATA A BILICO
DI.BIG - Soluzione 20**

26.2

SEZIONE VERTICALE - scala 1:2

v 1.6

DI.BI. PORTE BLINDATE Srl - Fano (PU) ITALY - www.dibigroup.com

LATO ESTERNO

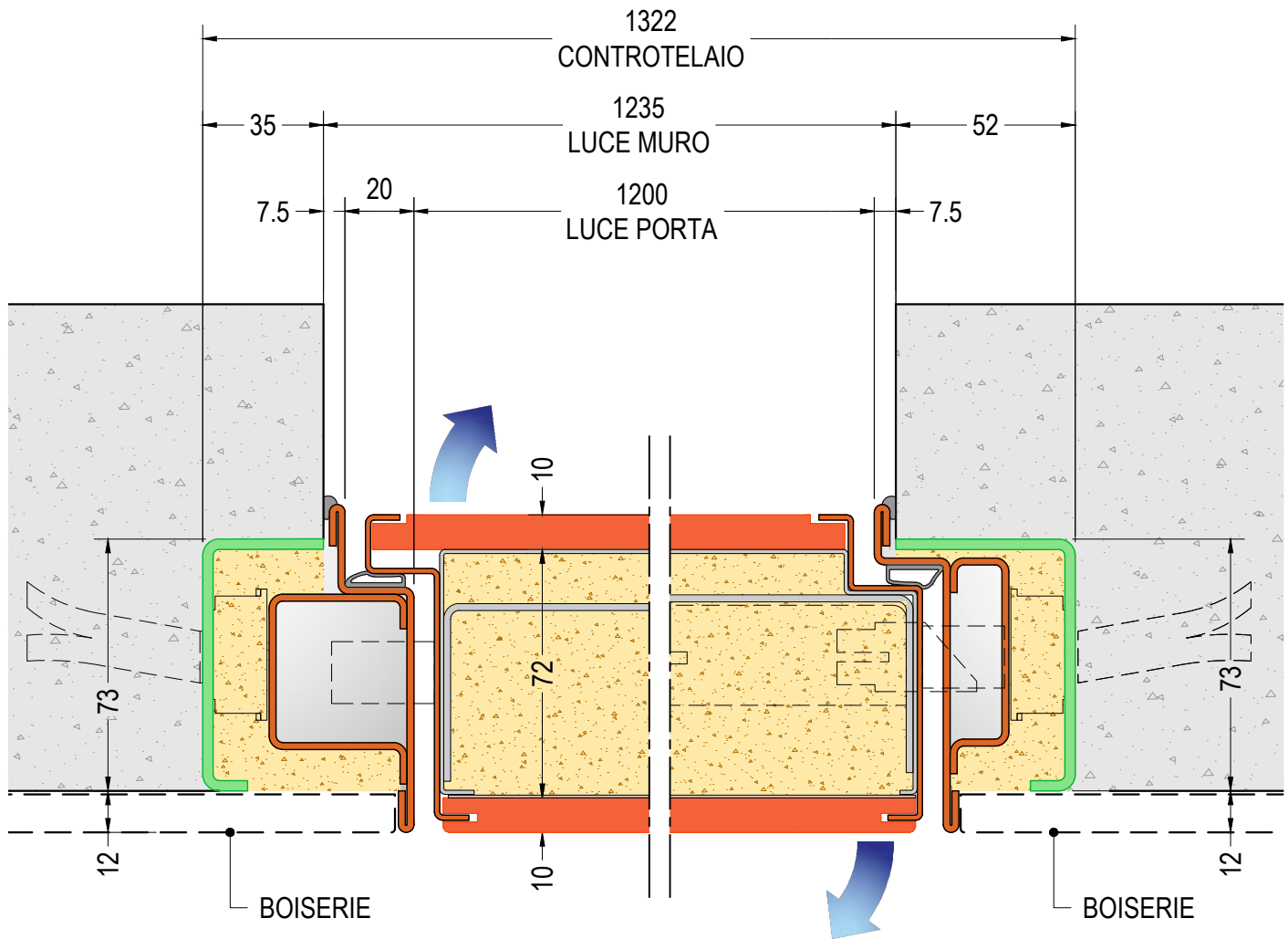

**SEZIONE ORIZZONTALE PORTA
MODELLO "A"**
rif. PORTA L=1200 (900+300)

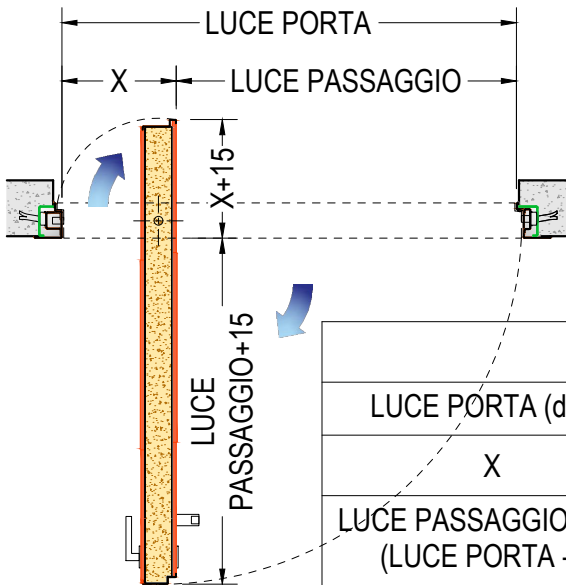

CALCOLO LUCE PASSAGGIO

| LUCE PORTA (da-a) | 1100-1300 | 1301-1400 | 1401-1550 | 1551-1700 | 1701-1800 |
|---|-----------|-----------|-----------|-----------|-----------|
| X | 300 | 350 | 400 | 450 | 500 |
| LUCE PASSAGGIO (da-a) (LUCE PORTA - X) | 800-1000 | 951-1050 | 1001-1150 | 1001-1250 | 1201-1300 |

**CONTROTELAIO E TELAIO PORTA A
BILICO DI.BIG per rivestimento
muro interno - Soluzione 21**

26.3

SEZIONE ORIZZONTALE - scala 1:2

v 1.6

DI.BI. PORTE BLINDATE Srl - Fano (PU) ITALY - www.dibigroup.com

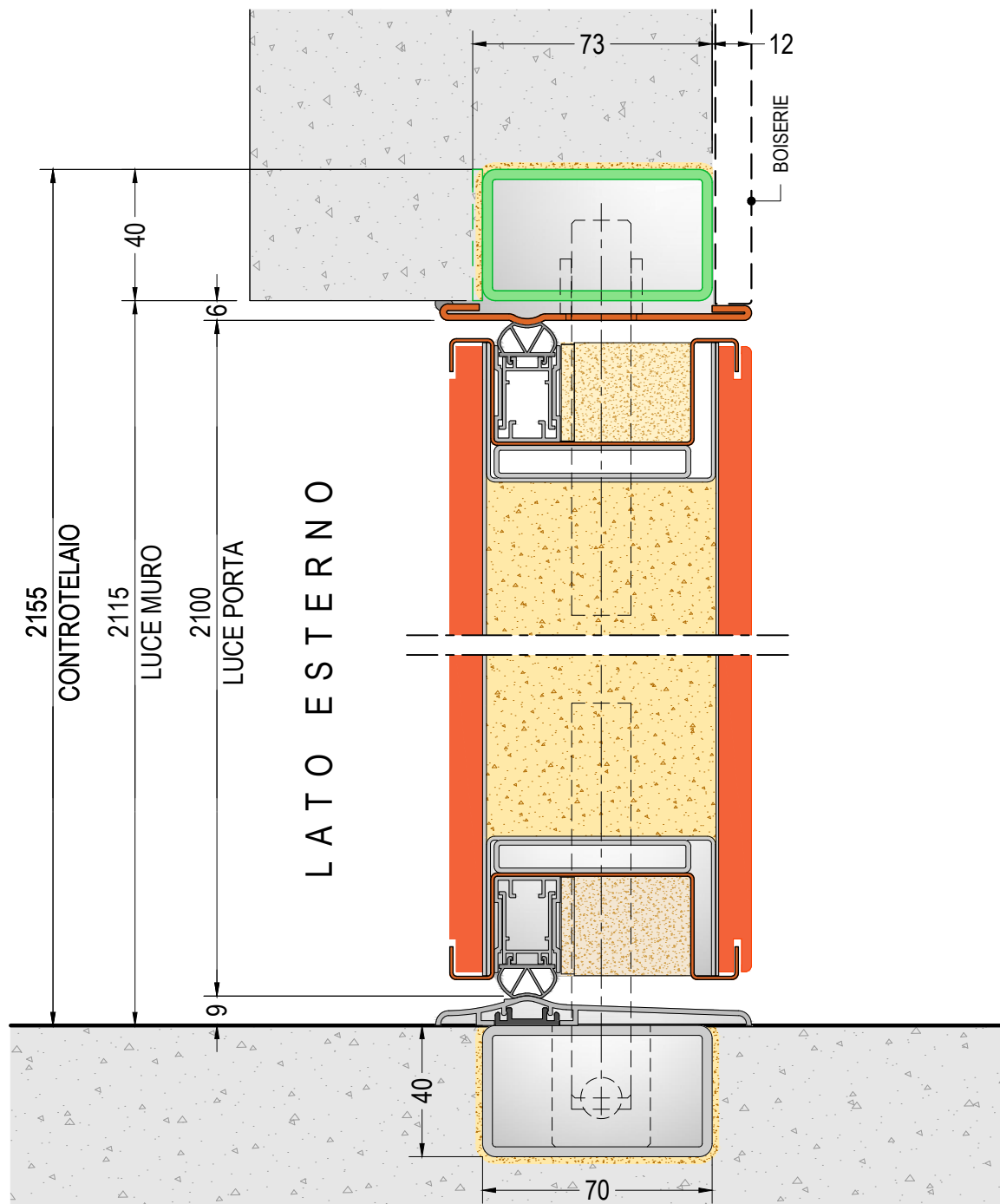

**SEZIONE VERTICALE PORTA
MODELLO "A"**

rif. PORTA H=2100

DIMENSIONI PORTA:

L=min. 1100 - max. 1800

H=min. 2100 - max. 2800



vista lato esterno



**CONTROTELAIO E TELAIO PORTA A
BILICO DI.BIG per rivestimento
muro interno - Soluzione 21**

26.4

SEZIONE ORIZZONTALE - scala 1:2

v 1.6

DI.BI. PORTE BLINDATE Srl - Fano (PU) ITALY - www.dibigroup.com

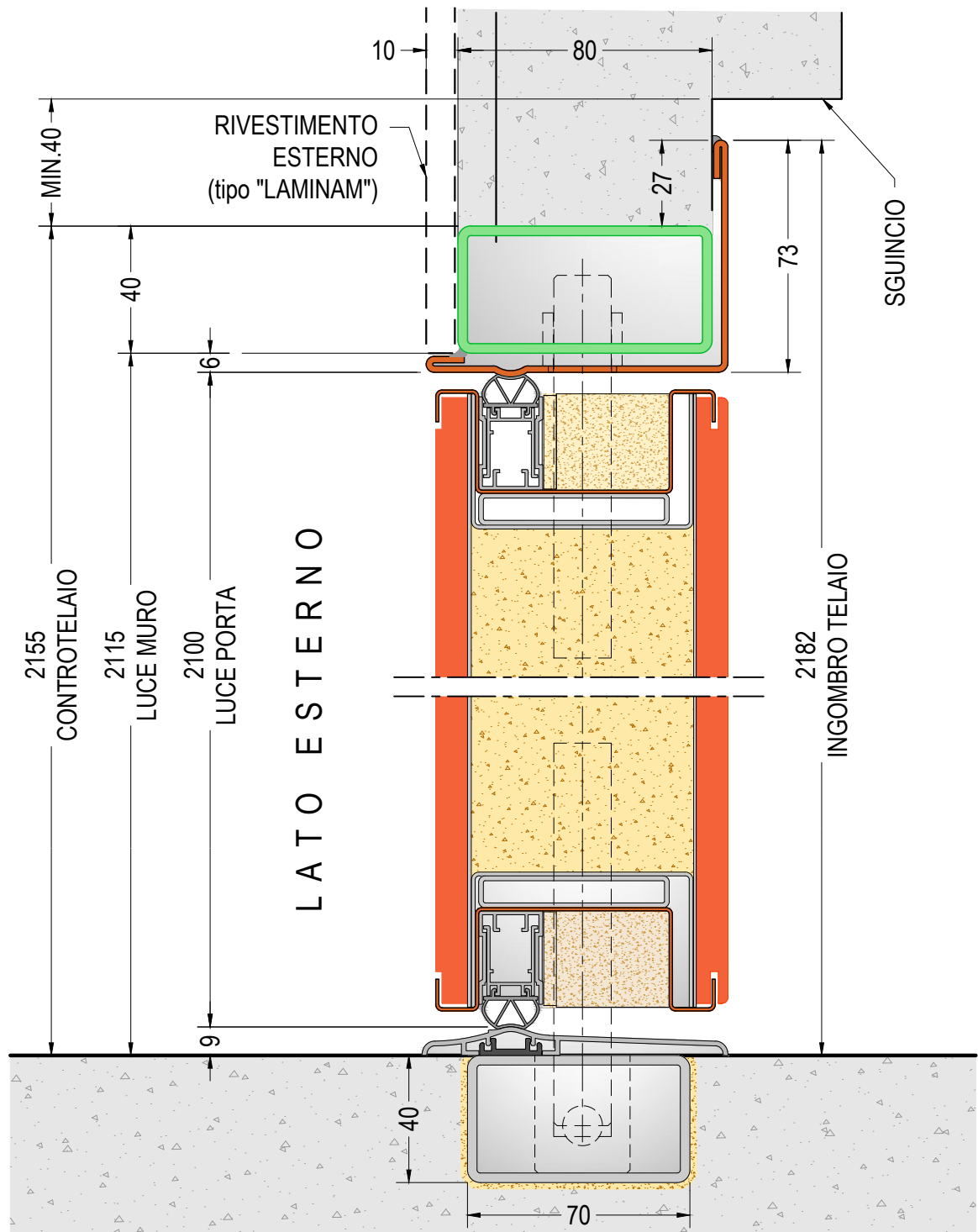

**SEZIONE VERTICALE PORTA
MODELLO "A"**
rif. PORTA H=2100

DIMENSIONI PORTA:
L=min. 1100 - max. 1800
H=min. 2100 - max. 2800



vista lato esterno



**CONTROTELAIO E TELAIO PORTA
A BILICO DI.BIG per rivestimento
muro esterno - Soluzione 22**

26.6

SEZIONE ORIZZONTALE - scala 1:2

v 1.6

DI.BI. PORTE BLINDATE Srl - Fano (PU) ITALY - www.dibigroup.com

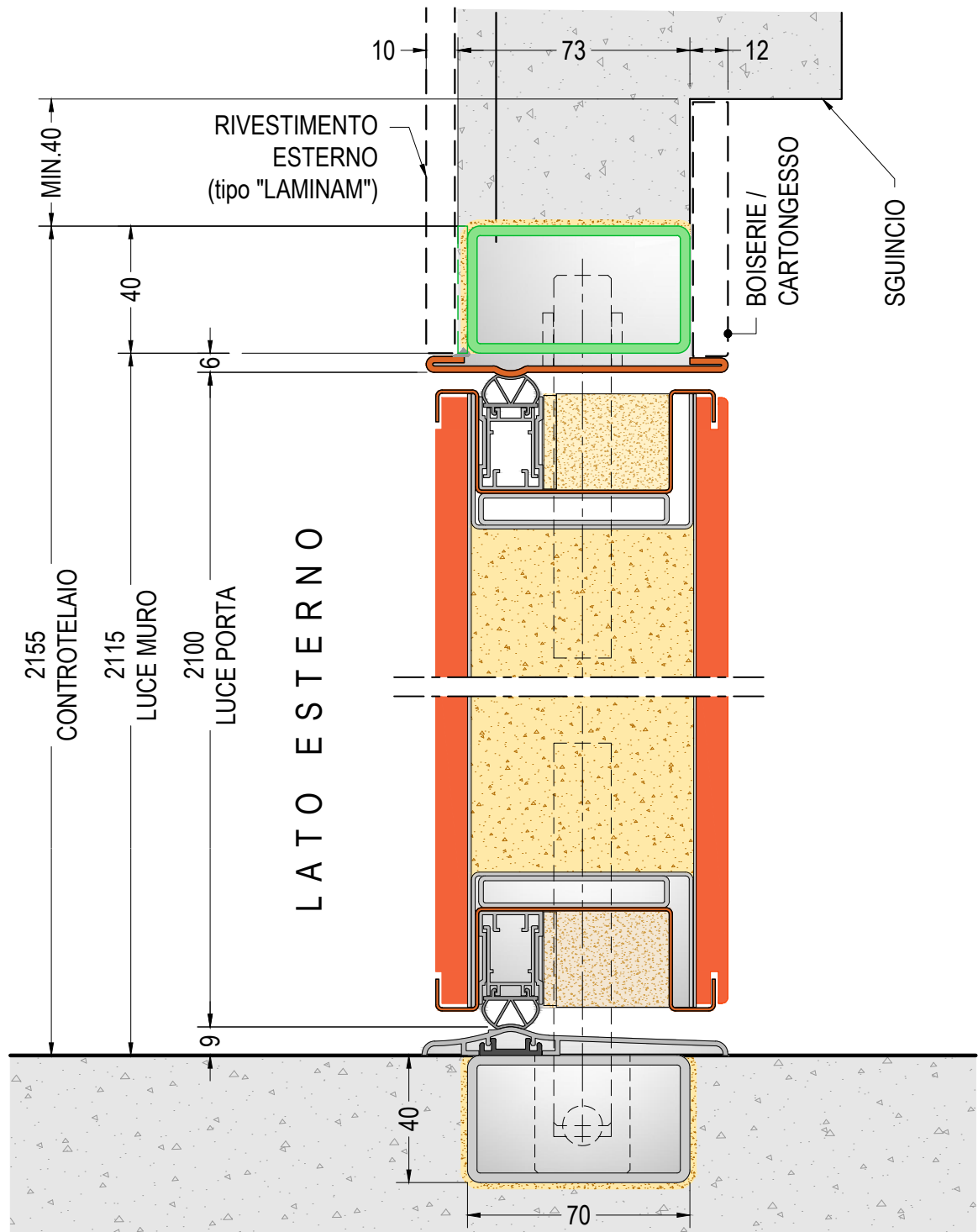

**SEZIONE VERTICALE PORTA
MODELLO "A"**
rif. PORTA H=2100

DIMENSIONI PORTA:
L=min. 1100 - max. 1800
H=min. 2100 - max. 2800



vista lato esterno



**CONTROTELAIO E TELAIO PORTA A
BILICO DI.BIG per rivestimento
muro interno e esterno - Soluzione 23**

26.8

SEZIONE ORIZZONTALE - scala 1:2

v 1.6

DI.BI. PORTE BLINDATE Srl - Fano (PU) ITALY - www.dibigroup.com

LATO ESTERNO

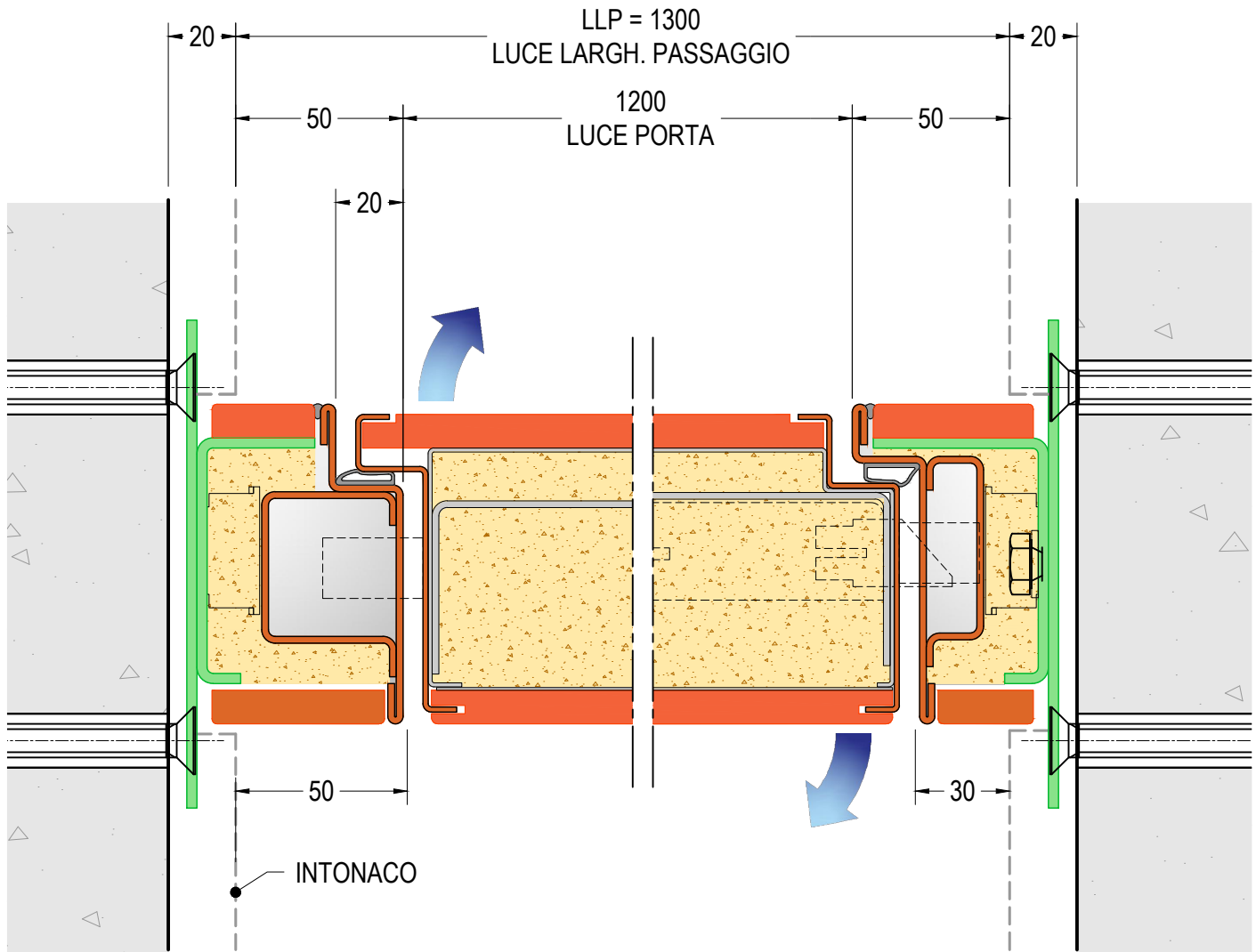

SEZIONE ORIZZONTALE PORTA MODELLO "A"

ref. PORTA L=1200 (900+300)

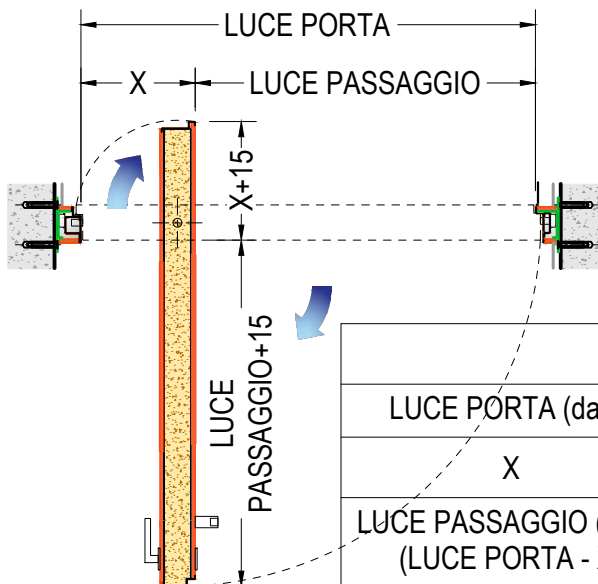

CALCOLO LUCE PASSAGGIO

| LUCE PORTA (da-a) | 1100-1300 | 1301-1400 | 1401-1550 | 1551-1700 | 1701-1800 |
|---|-----------|-----------|-----------|-----------|-----------|
| X | 300 | 350 | 400 | 450 | 500 |
| LUCE PASSAGGIO (da-a) (LUCE PORTA - X) | 800-1000 | 951-1050 | 1001-1150 | 1001-1250 | 1201-1300 |

CONTROTELAIO E TELAIO PORTA A BILICO DI.BIG TUNNEL

Soluzione 24

SEZIONE ORIZZONTALE - scala 1:2

26.9

v 1.9

DI.BI. PORTE BLINDATE Srl - Fano (PU) ITALY - www.dibigroup.com

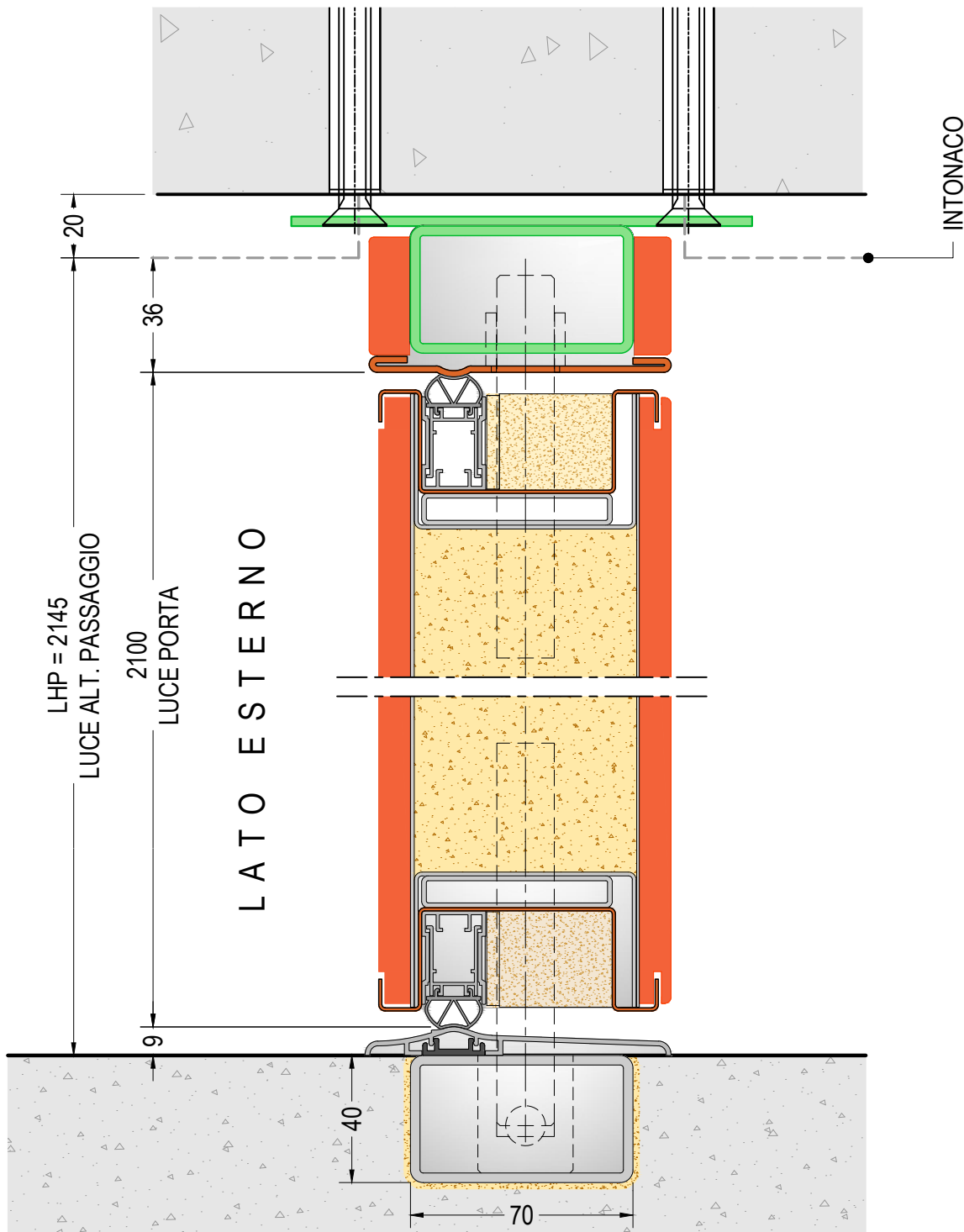

**SEZIONE VERTICALE PORTA
MODELLO "A"**
rif. PORTA H=2100

DIMENSIONI PORTA:
L=min. 1100 - max. 1800
H=min. 2100 - max. 2800



vista lato esterno



**CONTROTELAIO E TELAIO PORTA
A BILICO DI.BIG TUNNEL**
Soluzione 24

26.10

SEZIONE ORIZZONTALE - scala 1:2

v 1.9

DI.BI. PORTE BLINDATE Srl - Fano (PU) ITALY - www.dibigroup.com

LATO ESTERNO

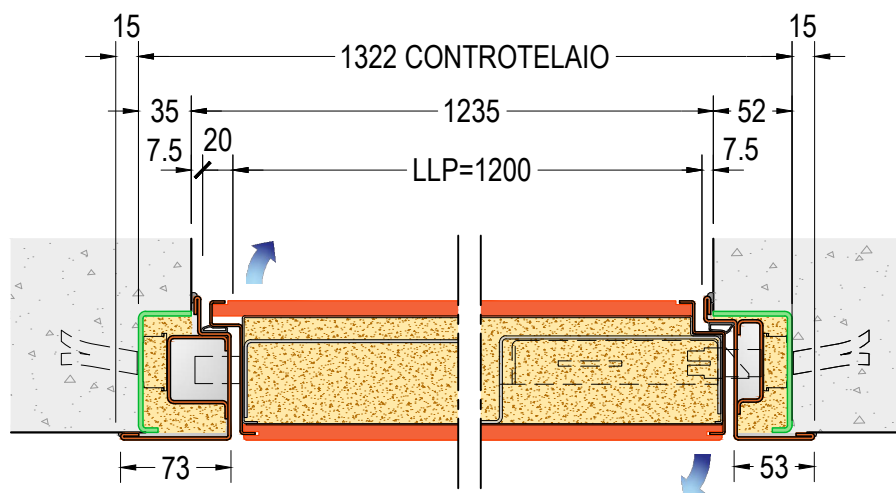

SEZIONE ORIZZONTALE PORTA - MODELLO "B"
rif. PORTA L=1200 - LUCE LARGH. PASSAGGIO LLP=1200

LATO ESTERNO

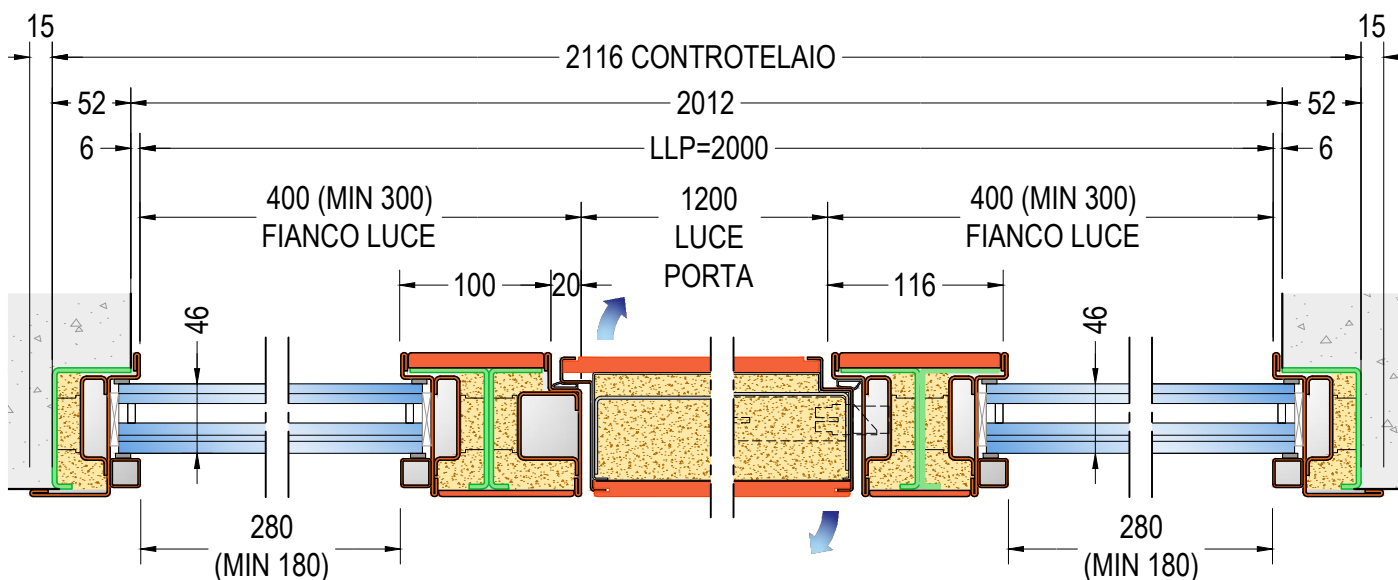

SEZIONE ORIZZONTALE PORTA - MODELLI "E-F"
rif. PORTA L=1200 - FIANCOLUCE 400
LUCE LARGH. PASSAGGIO LLP=2000

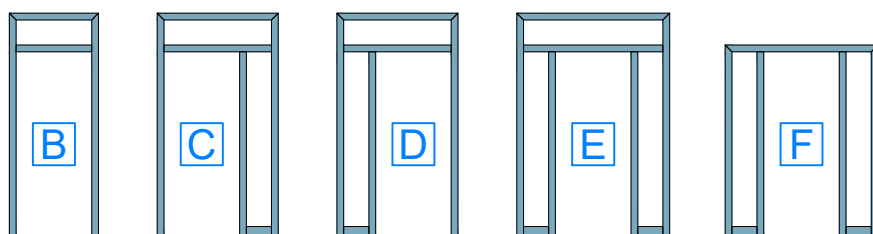

vista lato esterno

**CONTROTELAIO E TELAIO PORTA
A BILICO DI.BIG CON FIANCOLUCE
E SOPRALUCE**

27.1

SEZIONI ORIZZONTALI - scala 1:5

v1.7

DI.BI. PORTE BLINDATE Srl - Fano (PU) ITALY - www.dibigroup.com

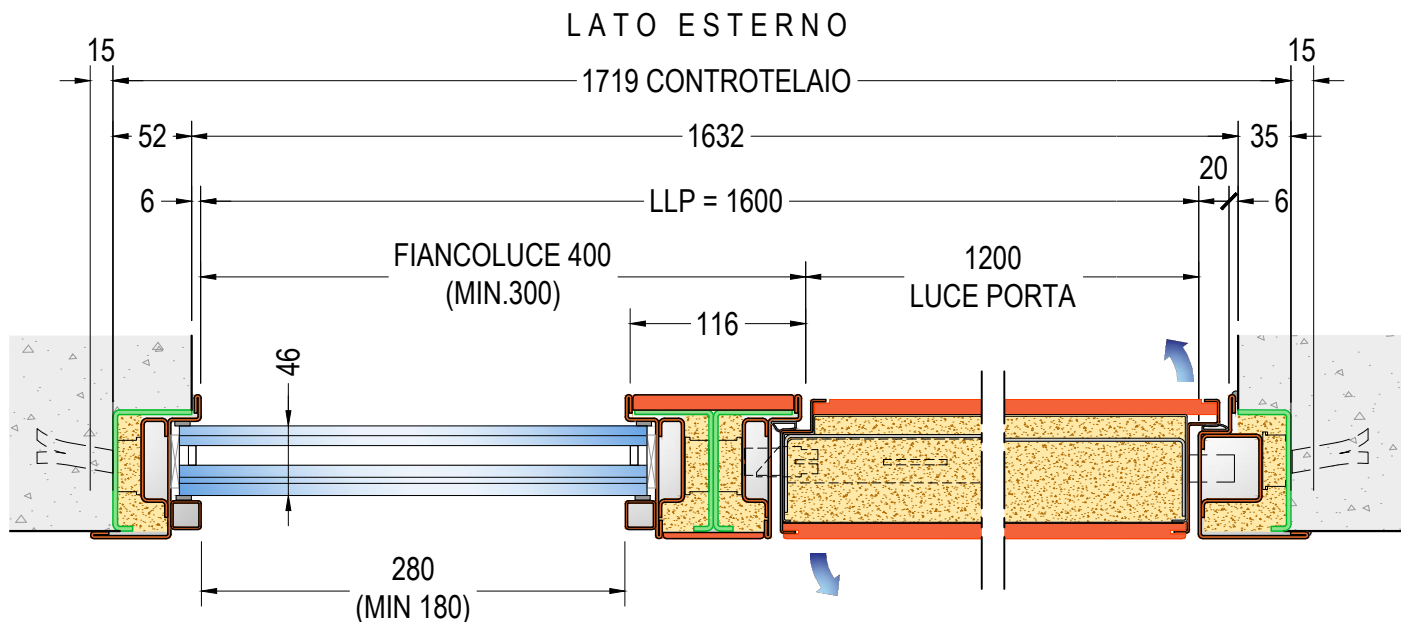

SEZIONE ORIZZONTALE PORTA - MODELLI "C-G"

rif. PORTA L=1200 - FIANCO LUCE 400
LUCE LAGRH. PASSAGGIO LLP=1600

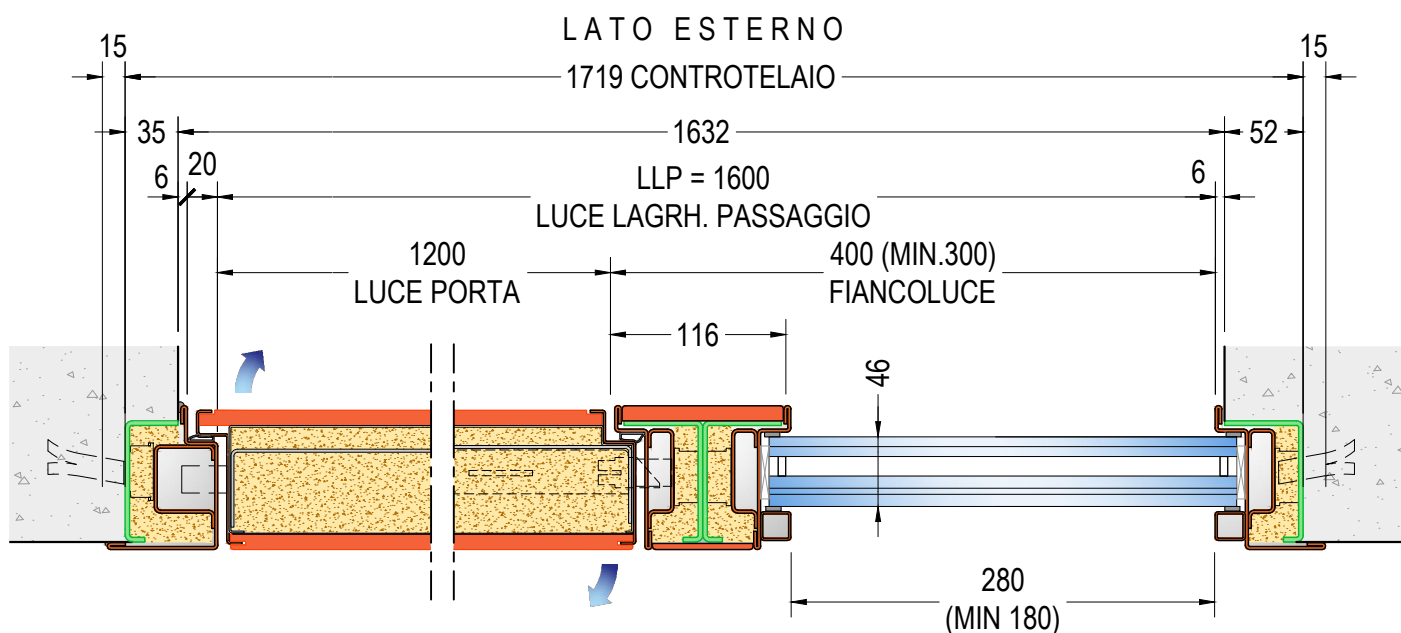

SEZIONE ORIZZONTALE PORTA - MODELLI "D-H"

rif. PORTA L=1200 - FIANCOLUCE 400
LUCE LAGRH. PASSAGGIO LLP=1600

LUCE PASSAGGIO:
MASSIMO INGOMBRO REALIZZABILE
(LLPxLHP / LHPxLLP)
2900x3700 (CDE) 3700x2700 (FGH)

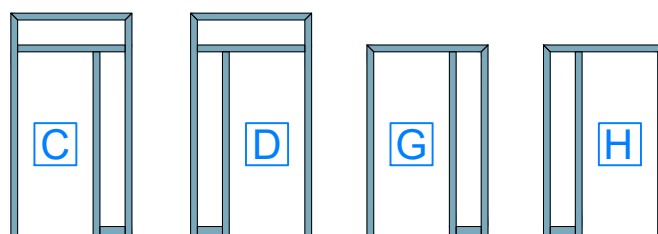

vista lato esterno



**CONTROTELAIO E TELAIO PORTA
A BILICO DI.BIG CON FIANCOLUCE
E SOPRALUCE**

27.2

SEZIONI ORIZZONTALI - scala 1:5

v1.7

DI.BI. PORTE BLINDATE Srl - Fano (PU) ITALY - www.dibigroup.com

LATO ESTERNO

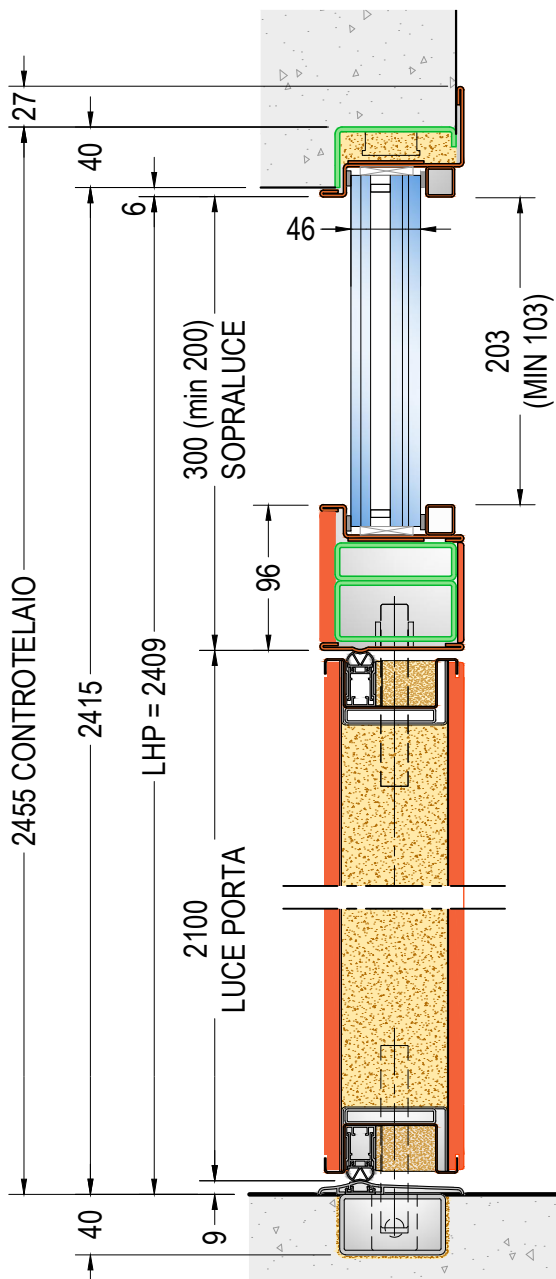

**SEZIONE VERTICALE PORTA
MODELLI "B-C-D-E"**

rif. PORTA H=2100 - SOPRALUCE 300
LUCE ALT. PASSAGGIO LHP=2409

LATO ESTERNO

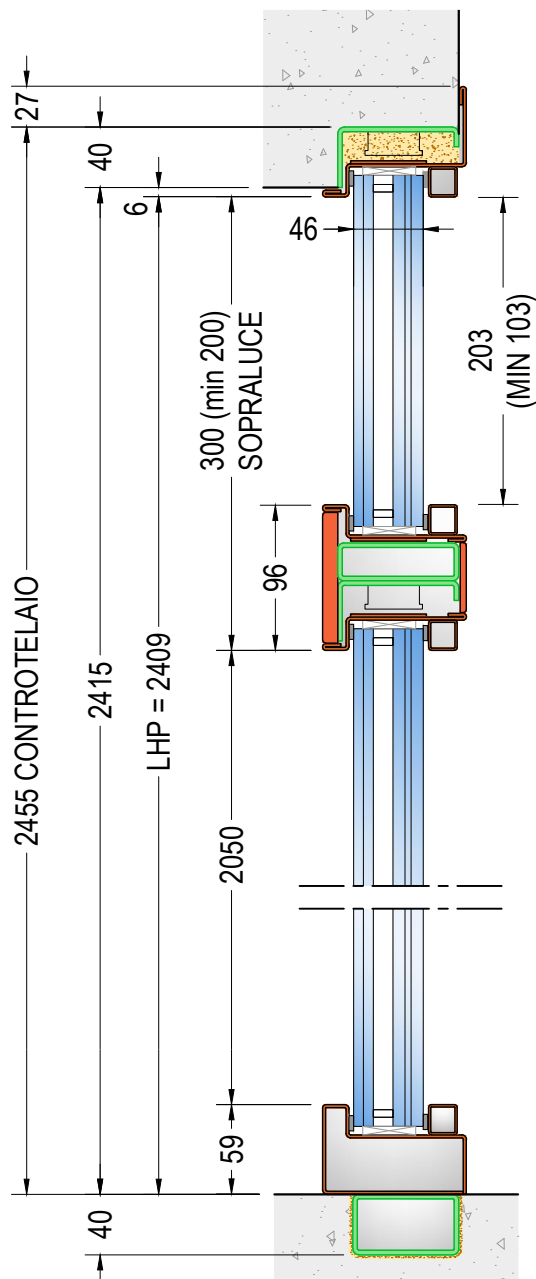

**SEZIONE VERTICALE FIANCOLUCE
MODELLI "C-D-E"**

rif. PORTA H=2100 - SOPRALUCE 300
LUCE ALT. PASSAGGIO LHP=2409

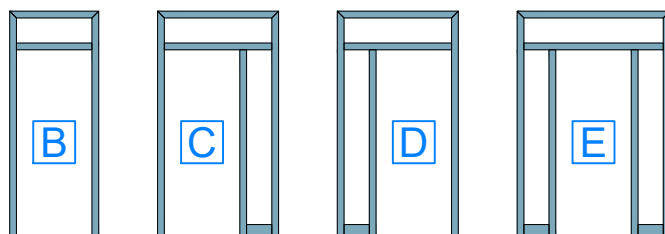

vista lato esterno



SICUREZZA & DESIGN

**CONTROTELAIO E TELAIO
PORTA A BILICO DI.BIG CON
FIANCOLUCE E SOPRALUCE**

27.3

SEZIONI VERTICALI - scala 1:2

v1.7

DI.BI. PORTE BLINDATE Srl - Fano (PU) ITALY - www.dibigroup.com

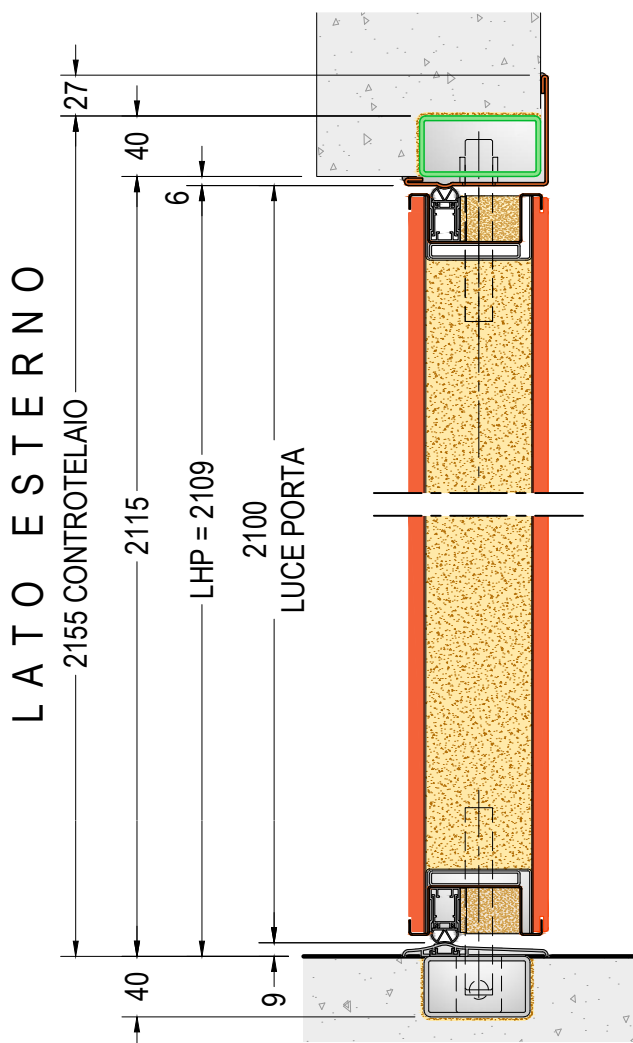

**SEZIONE VERTICALE PORTA
MODELLI "F-G-H"**
rif. PORTA H=2100
LUCE ALT. PASSAGGIO LHP=2109

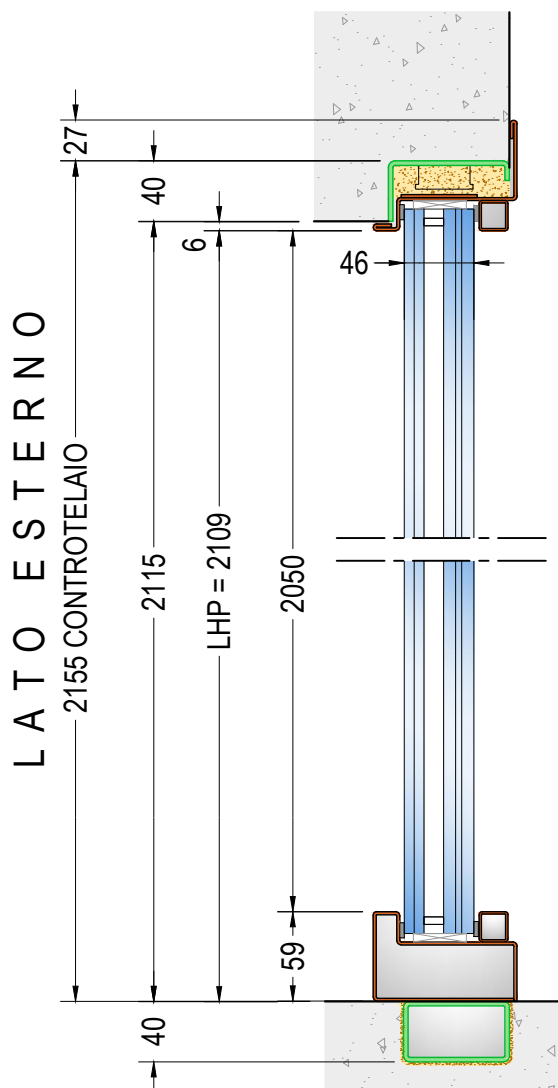

**SEZIONE VERTICALE FIANCOLUCE
MODELLI "F-G-H"**
rif. PORTA H=2100
LUCE ALT. PASSAGGIO LHP=2109

LUCE PASSAGGIO:
MASSIMO INGOMBRO REALIZZABILE
(LLPxLHP / LHPxLLP)
2900x3700 (CDE) 3700x2700 (FGH)

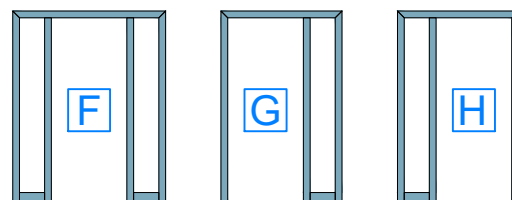

vista lato esterno



**CONTROTELAIO E TELAIO
PORTA A BILICO DI.BIG CON
FIANCOLUCE E SOPRALUCE**

27.4

SEZIONI VERTICALI - scala 1:2

v1.7

DI.BI. PORTE BLINDATE Srl - Fano (PU) ITALY - www.dibigroup.com

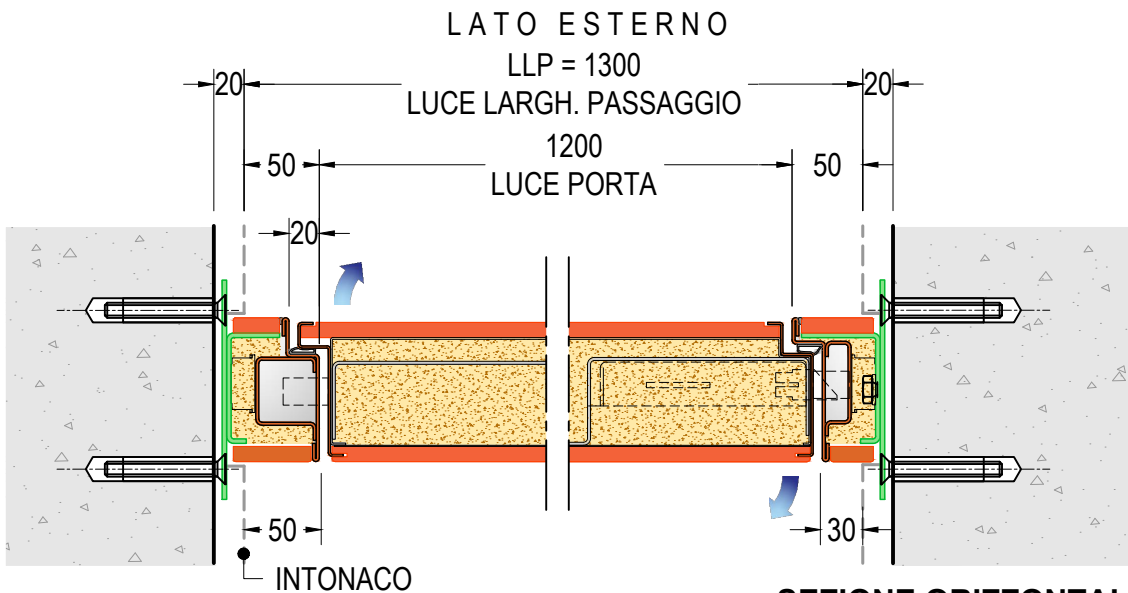

**SEZIONE ORIZZONTALE PORTA
verso di apertura DX - MODELLO "B"**
rif. PORTA L=1200 - LUCE LARGH. PASSAGGIO LLP=1300

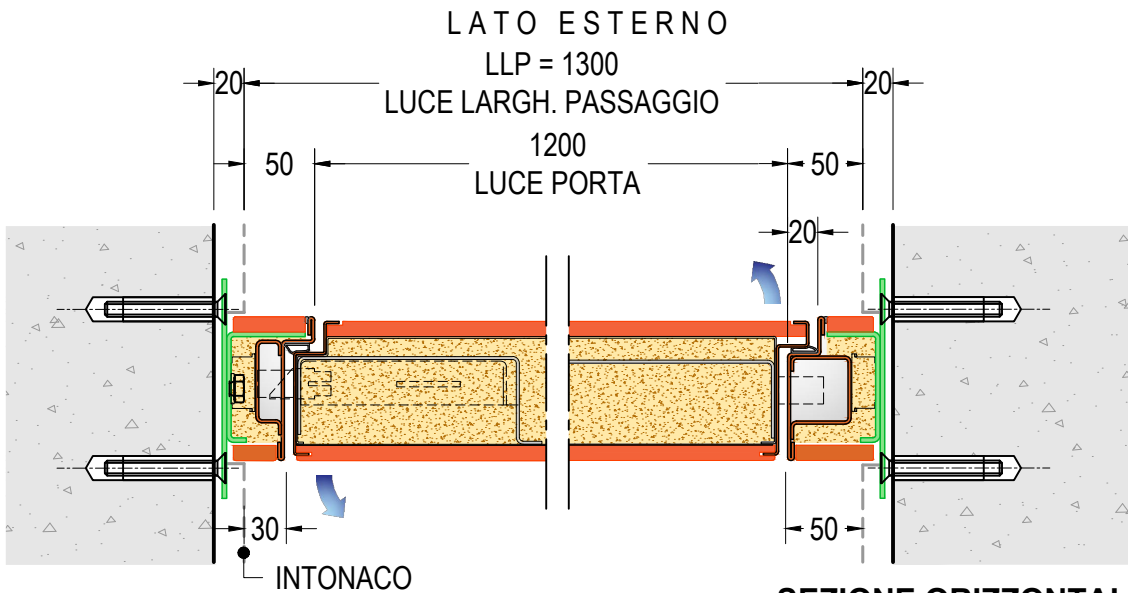

**SEZIONE ORIZZONTALE PORTA
verso di apertura SX - MODELLO "B"**
rif. PORTA L=1200 - LUCE LARGH. PASSAGGIO LLP=1300

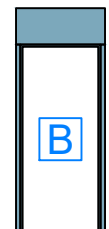

vista lato esterno



**CONTROTELAIO E TELAIO
PORTA A BILICO DI.BIG CON
PARETI LATERALI E SUPERIORI**

28.1

SEZIONI ORIZZONTALI - scala 1:5

v1.9

DI.BI. PORTE BLINDATE Srl - Fano (PU) ITALY - www.dibigroup.com

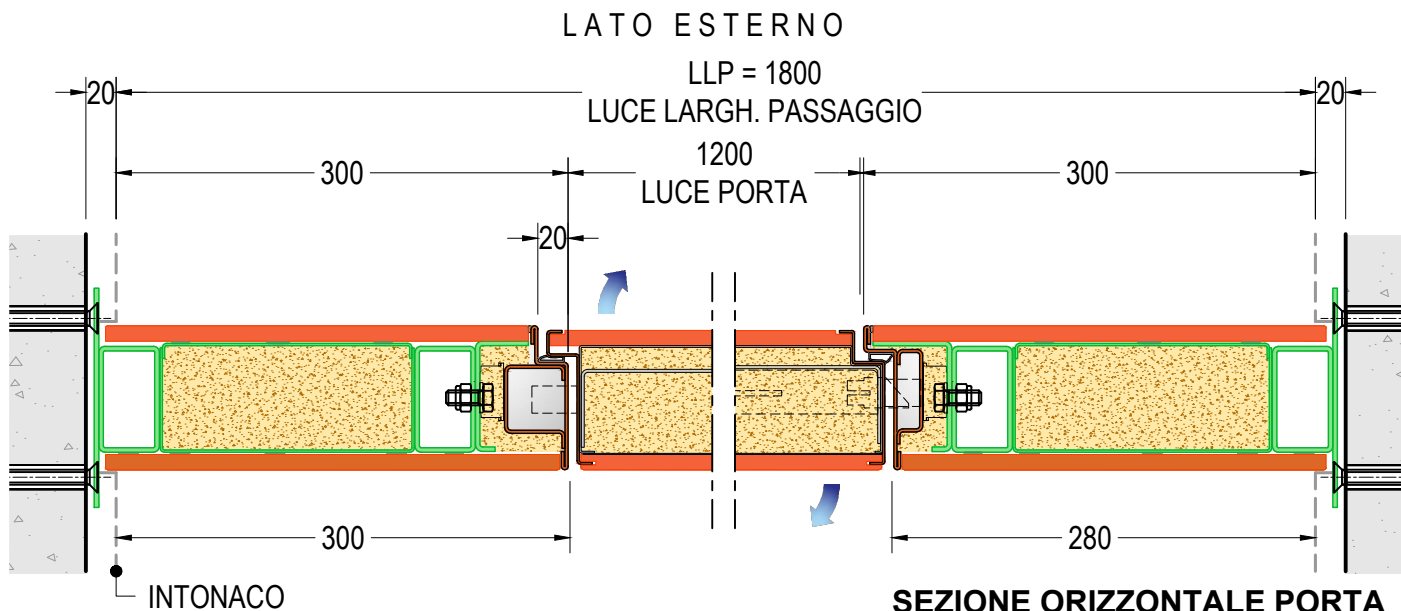

SEZIONE ORIZZONTALE PORTA
verso di apertura DX - MODELLI "E-F"
 rif. PORTA L=1200 - PARETI LATERALI 300
 LUCE LARGH. PASSAGGIO LLP=1800

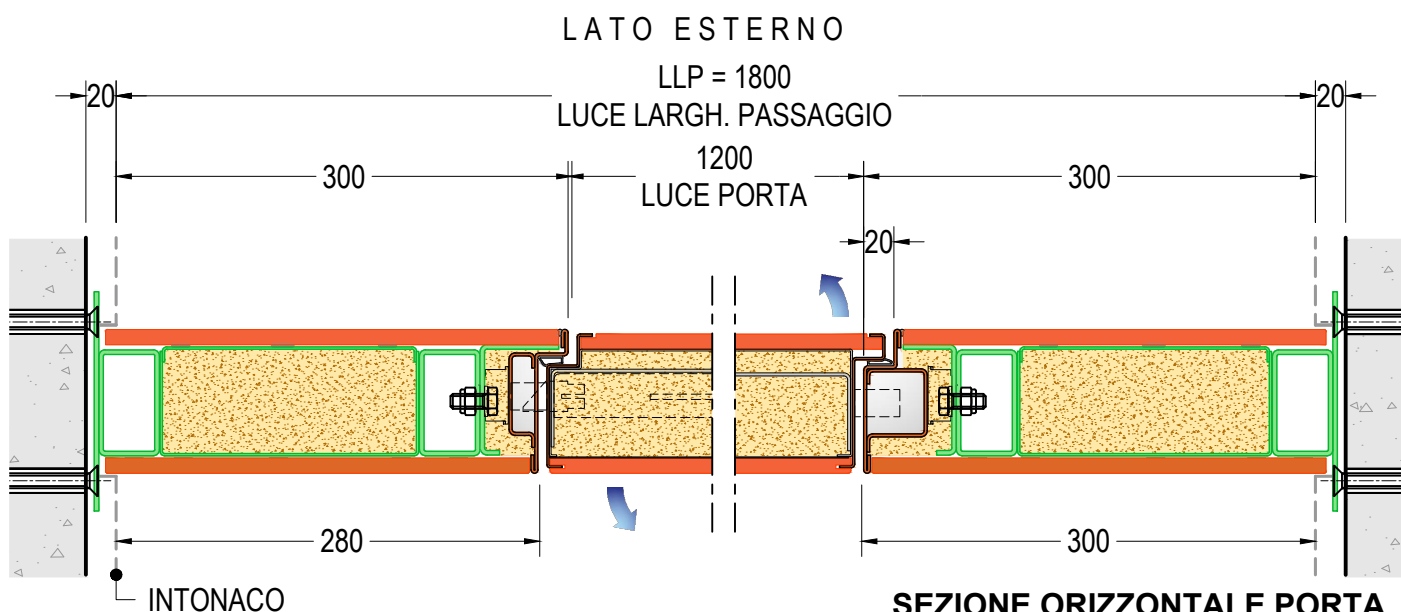

SEZIONE ORIZZONTALE PORTA
verso di apertura SX - MODELLI "E-F"
 rif. PORTA L=1200 - PARETI LATERALI 300
 LUCE LARGH. PASSAGGIO LLP=1800

LUCE PASSAGGIO:
 MASSIMO INGOMBRO REALIZZABILE
 (LLPxLHP / LHPxLLP)
 2900x3700 (CDE) 3700x2700 (FGH)

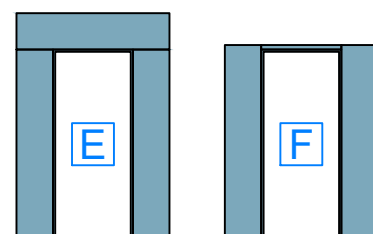

vista lato esterno



CONTROTELAIO E TELAIO
PORTA A BILICO DI.BIG CON
PARETI LATERALI E SUPERIORI

28.2

SEZIONI ORIZZONTALI - scala 1:5

v1.9

DI.BI. PORTE BLINDATE Srl - Fano (PU) ITALY - www.dibigroup.com

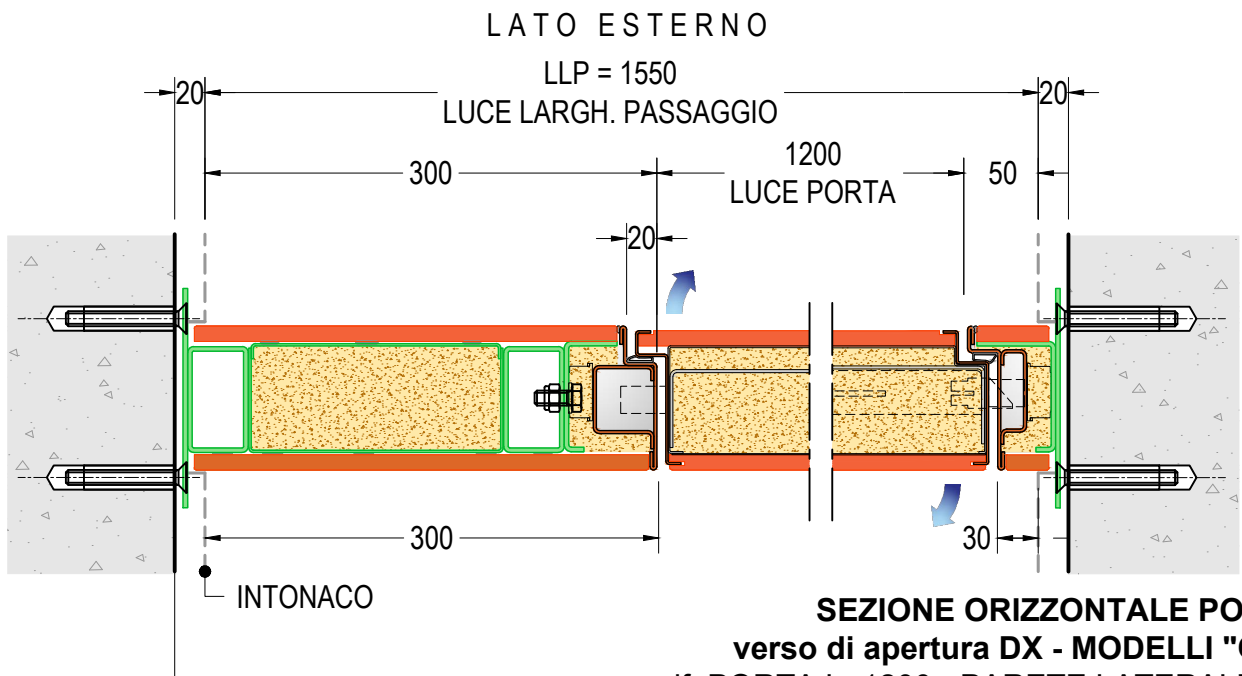

SEZIONE ORIZZONTALE PORTA
verso di apertura DX - MODELLI "C-G"
 rif. PORTA L=1200 - PARETE LATERALE 300
 LUCE LARGH. PASSAGGIO LLP=1570

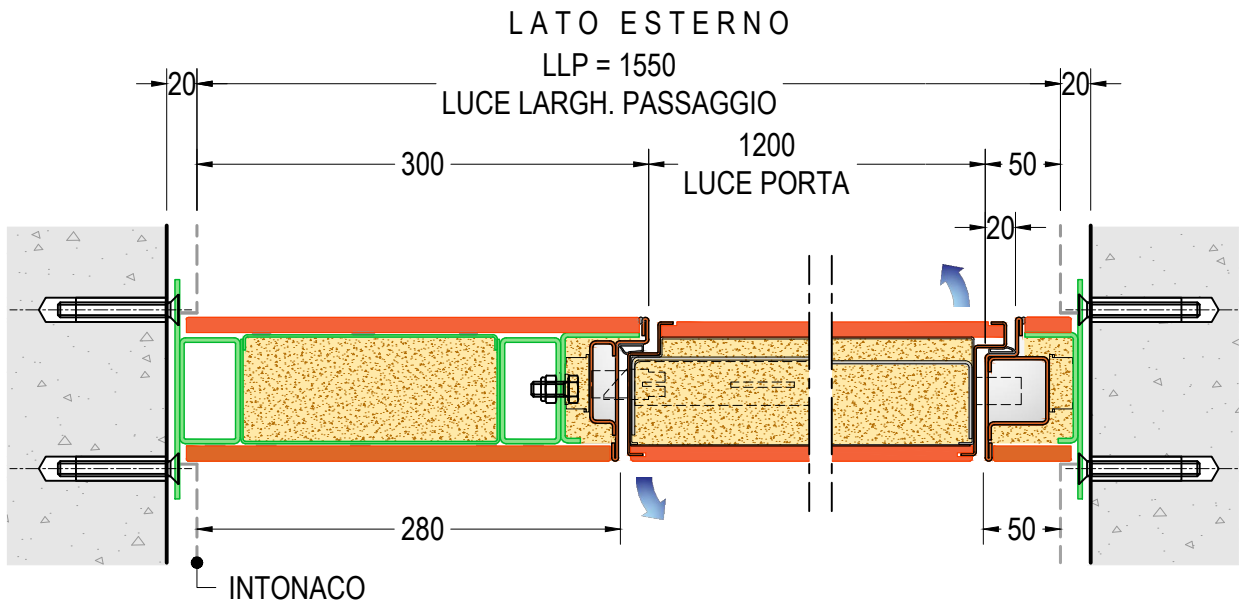

SEZIONE ORIZZONTALE PORTA
verso di apertura SX - MODELLI "C-G"
 rif. PORTA L=1200 - PARETE LATERALE 300
 LUCE LARGH. PASSAGGIO LLP=1550

LUCE PASSAGGIO:
 MASSIMO INGOMBRO REALIZZABILE
 (LLPxLHP / LHPxLLP)
 2900x3700 (CDE) 3700x2700 (FGH)

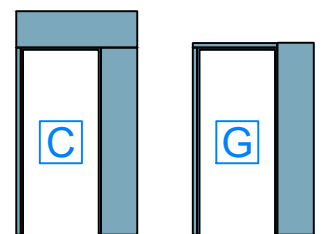

vista lato esterno



CONTROTELAIO E TELAIO
PORTA A BILICO DI.BIG CON 28.3
PARETI LATERALI E SUPERIORI

SEZIONI ORIZZONTALI - scala 1:5

v2.0

DI.BI. PORTE BLINDATE Srl - Fano (PU) ITALY - www.dibigroup.com

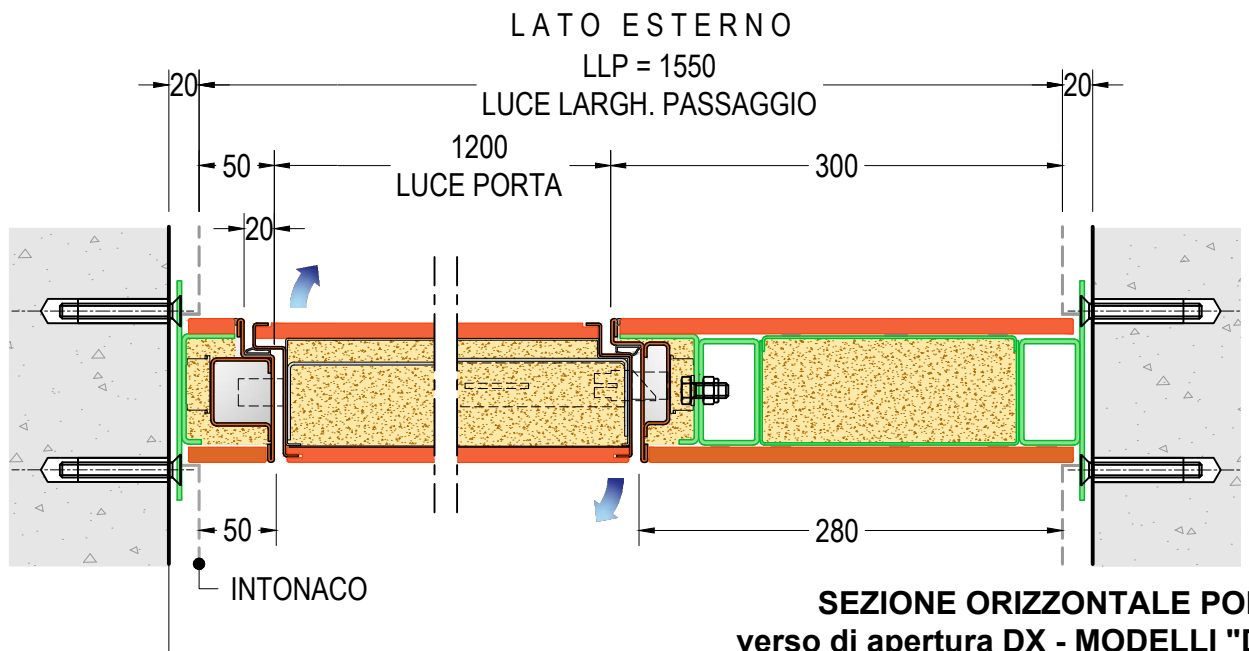

SEZIONE ORIZZONTALE PORTA
verso di apertura DX - MODELLI "D-H"
rif. PORTA L=1200 - PARETE LATERALE 300
LUCE LARGH. PASSAGGIO LLP=1550

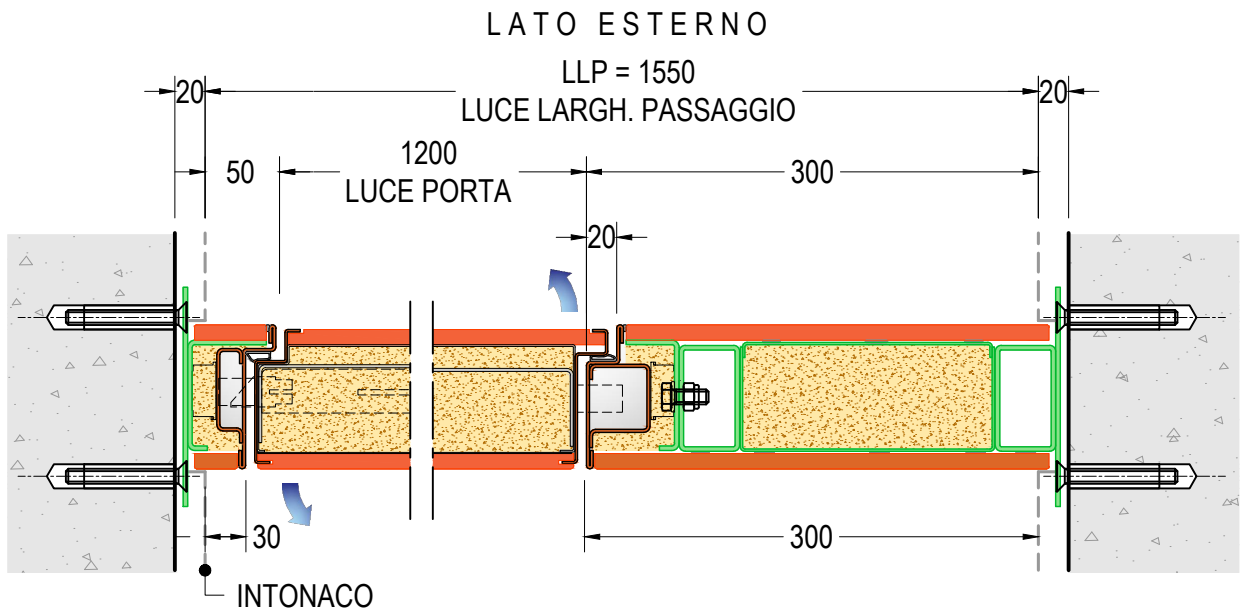

SEZIONE ORIZZONTALE PORTA
verso di apertura SX - MODELLI "D-H"
rif. PORTA L=1200 - PARETE LATERALE 300
LUCE LARGH. PASSAGGIO LLP=1570

LUCE PASSAGGIO:
MASSIMO INGOMBRO REALIZZABILE
(LLPxLHP / LHPxLLP)
2900x3700 (CDE) 3700x2700 (FGH)

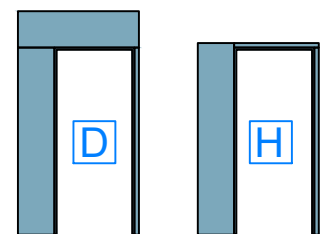

vista lato esterno



CONTROTELAIO E TELAIO
PORTA A BILICO DI.BIG CON
PARETI LATERALI E SUPERIORI

28.4

SEZIONI ORIZZONTALI - scala 1:5

v2.0

DI.BI. PORTE BLINDATE Srl - Fano (PU) ITALY - www.dibigroup.com

LATO ESTERNO

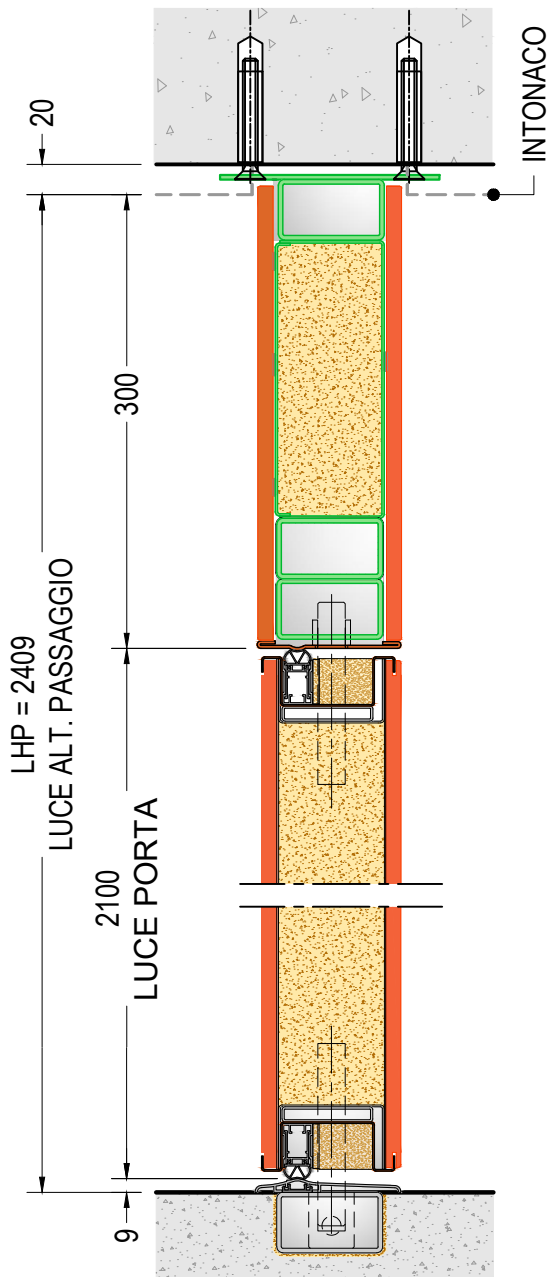

**SEZIONE VERTICALE PORTA
MODELLI "B-C-D-E"**

rif. PORTA H=2100 - PARETE SUPER. 300
LUCE ALT. PASSAGGIO LHP=2409

LATO ESTERNO

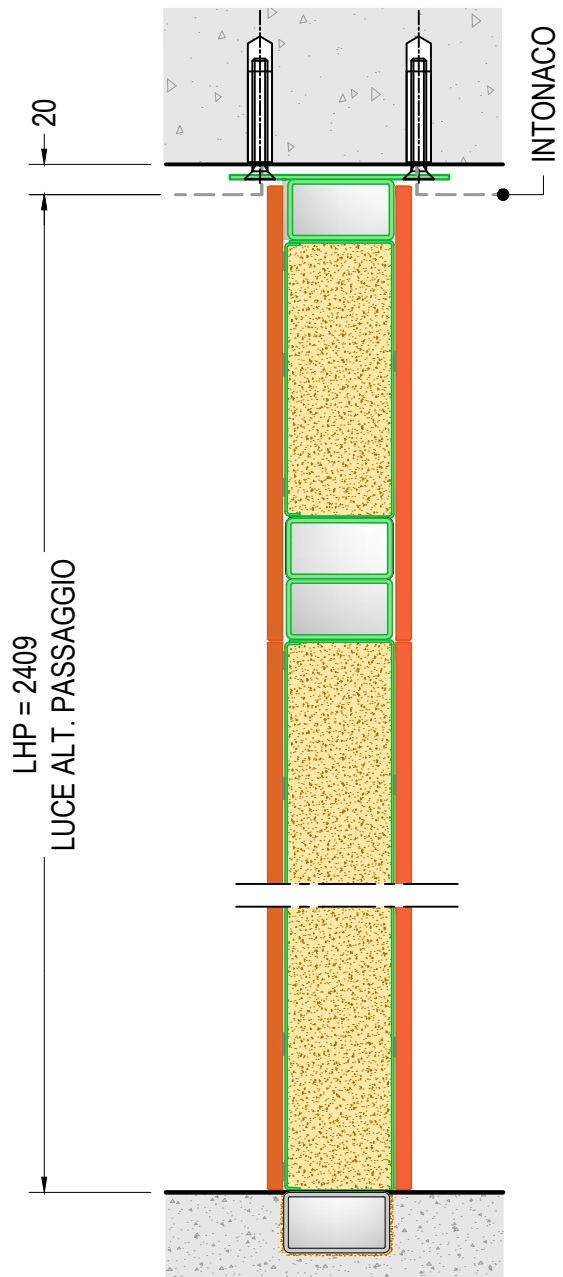

**SEZIONE VERTICALE PARETE LATERALE
MODELLI "C-D-E"**

rif. PORTA H=2100 - PARETE SUPER. 300
LUCE ALT. PASSAGGIO LHP=2409

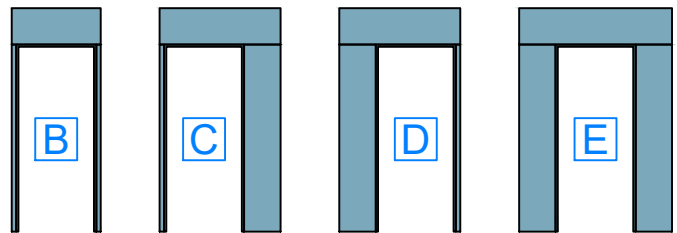

vista lato esterno



**CONTROTELAIO E TELAIO
PORTA A BILICO DI.BIG CON
PARETI LATERALI E SUPERIORI**

28.5

SEZIONI VERTICALI - scala 1:2

v1.7

DI.BI. PORTE BLINDATE Srl - Fano (PU) ITALY - www.dibigroup.com

LATO ESTERNO

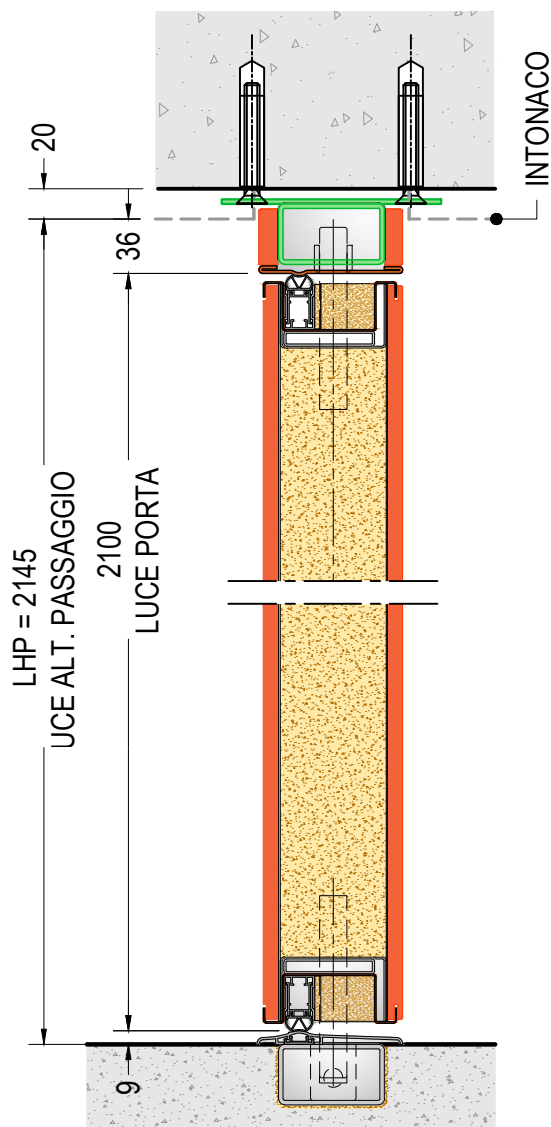

**SEZIONE VERTICALE PORTA
MODELLI "F-G-H"**
rif. PORTA H=2100
LUCE ALT. PASSAGGIO LHP=2145

LATO ESTERNO

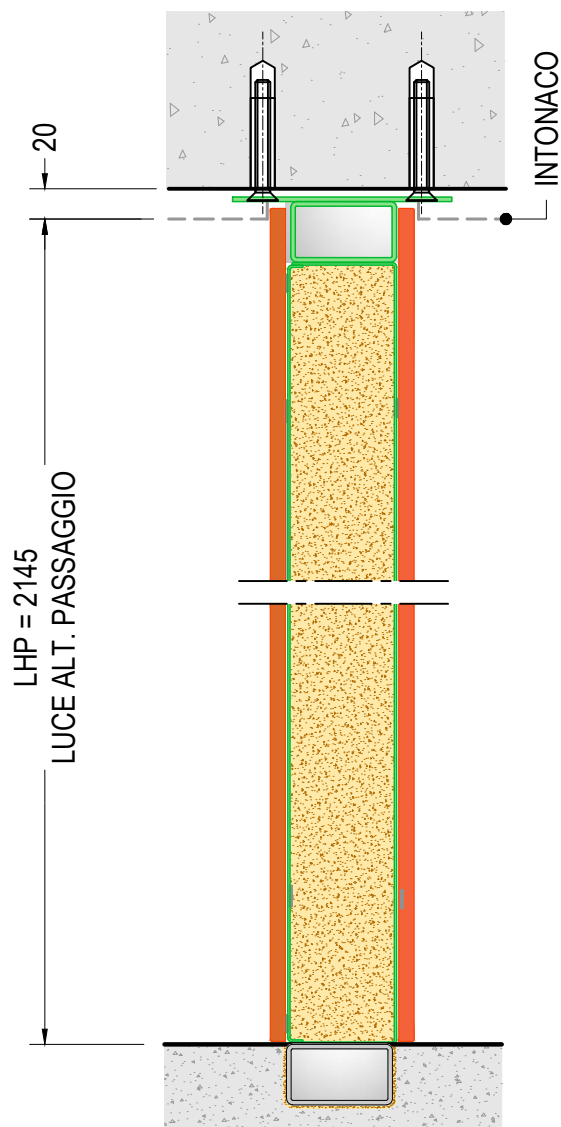

**SEZIONE VERTICALE PARETE LATERALE
MODELLI "F-G-H"**
rif. PORTA H=2100
LUCE ALT. PASSAGGIO LHP=2145

LUCE PASSAGGIO:
MASSIMO INGOMBRO REALIZZABILE
(LLPxLHP / LHPxLLP)
2900x3700 (CDE) 3700x2700 (FGH)

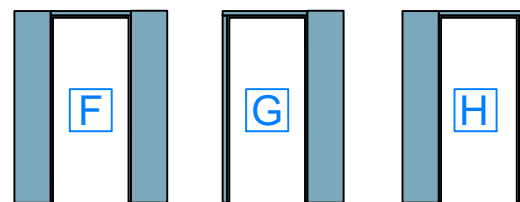

vista lato esterno



**CONTROTELAIO E TELAIO
PORTA A BILICO DI.BIG CON
PARETI LATERALI E SUPERIORI**

28.6

SEZIONI VERTICALI - scala 1:2

v1.7

DI.BI. PORTE BLINDATE Srl - Fano (PU) ITALY - www.dibigroup.com



NOTE

DI.BI. PORTE BLINDATE Srl - Fano (PU) ITALY - www.dibigroup.com



DI.BI. PORTE BLINDATE Srl - Fano (PU) ITALY - www.dibigroup.com